

CUMMINS / DQCB 750



**Sales and
Service**

Cummins Sales and Service

NOTICE

A COPY OF THIS GENERATOR SET SUBMITTAL MUST BE RETURNED TO OUR OFFICE, APPROVED IN ITS ENTIRETY AND BEARING THE DATE OF APPROVAL, STAMP OR SIGNATURE AND TITLE OF THE APPROVING AUTHORITY, BEFORE ANY ITEM WILL BE RELEASED FOR MANUFACTURE OR SHIPMENT. WE ASSUME NO RESPONSIBILITY FOR DELAYS IN OUR FORECASTED SHIPPING SCHEDULES ON ANY ITEM ON WHICH SUBMITTAL APPROVAL IS BEYOND THIRTY (30) DAYS FROM THE SUBMISSION DATE ON THE COVER PAGE.

THIS SUBMITTAL IS BASED UPON OUR INTERPRETATION OF THE PROJECT REQUIREMENTS AND/OR SPECIFICATIONS AND IS IN ACCORDANCE WITH YOUR ORDER AND PRODUCT AVAILABILITY OF FROM OUR VENDORS. PLEASE REVIEW THE ENCLOSED DATA COMPLETELY AND CAREFULLY. SHOULD ADDITIONAL INFORMATION OR CLARIFICATION BE REQUIRED PLEASE FORWARD A SUBMITTAL COPY, COMPLETE WITH YOUR NOTATIONS, TO OUR OFFICE WITHIN THIRTY (30) DAYS FOR A PROMPT RESPONSE AND/OR RESUBMITTAL.

CONSIDERABLE ATTENTION IS GIVEN TO THE PREPARATION OF THIS SUBMITTAL TO ENSURE IT IS COMPLETE, CONCISE AND CORRECT AS IS POSSIBLE. PLEASE REVIEW IT CAREFULLY AND THOROUGHLY.



Bill of Materials

Feature Code	Description	Qty
DQCB US-Stat 750DQCB A331-2 L170-2 C251-2 L163-2 L090-2 C127-2 C256-2 H609-2 H703-2 H678-2 KP74-2 H536-2 KU93-2 KP89-2 KB73-2 H723-2 D041-2 E074-2 H389-2 H557-2 R002-2 L028-2 B876-2 L050-2 A412-2 F202-2 P175-2 F208-2	DQCB, Commercial Diesel Generator Set, 750kW Standby 60Hz U.S. EPA, Stationary Emergency Application 750DQCB, Diesel Genset, 60Hz, 750kW Duty Rating-Standby Power (ESP) Emission Certification, EPA, Tier 2, NSPS CI Stationary Emergency Fuel Tank-Sub Base, 1500 Gallon, UL142 Compliant Listing, ULC-S601-07 Listing-UL 2200 Fuel Water Separator Fuel Tank Connection-Dual Stub Up Control Mounting-Left Facing PowerCommand 2.3 Controller LCD Control Display Stop Switch-Emergency, Externally Mounted Control Display Language-English Circuit Breaker or Entrance Box or Terminal Box-Left Only Circuit Breaker-1200, Left, 3P, UL 600, IEC 415, UL Serv Ent 100% Bottom Entry, Left Indication-Ground Fault, Terminal Box (or) Circuit Breaker Box-Left Engine Air Cleaner-Normal Duty Engine Cooling-Radiator, 50C Ambient Shutdown-Low Coolant Level Coolant Heater-208/240/480 Volts AC, Below 40F Ambient Temperature Voltage-277/480, 3 Phase, Wye, 4 Wire Genset Warranty-2 Years Base Alternator-60Hz, Wye, 480 Volts, 105C-Standby Literature-English Packing-None, Base Mounted Housing Steel Sound Attenuated Level 2 Enclosure, with Exhaust System Enclosure Color-Green, Steel Cooling Air Outlet-Horizontal , Sound Attenuated	1
A048G602	Battery Charger-10Amp, 120/208/240VAC, 12/24V, 50/60Hz	1



Diesel Generator Set QSK23 Series Engine

600 kW - 800 kW 60 Hz
Standby



Description

Cummins® commercial generator sets are fully integrated power generation systems providing optimum performance, reliability and versatility for stationary Standby and Prime Power applications.

Features

Cummins heavy-duty engine - Rugged 4-cycle, industrial diesel delivers reliable power, low emissions and fast response to load changes.

Alternator - Several alternator sizes offer selectable motor starting capability with low reactance 2/3 pitch windings, low waveform distortion with non-linear loads and fault clearing short-circuit capability.

Permanent Magnet Generator (PMG) - Offers enhanced motor starting and fault clearing short circuit capability.

Circuit breakers - Option for manually-and/or electrically-operated circuit breakers.

Control system - The PowerCommand® electronic control is standard equipment and provides total genset system integration including automatic remote starting/stopping, precise frequency, and voltage regulation, alarm and status message display, AmpSentry™ protection, output metering, auto-shutdown at fault detection and NFPA 110 Level 1 compliance.

Peer-to-peer paralleling - For applications where two or more generators with PowerCommand 3.3 control can be combined with an electrically operated circuit breaker and a combination of transfer switch(s).

Cooling system - Standard integral set-mounted radiator system, designed and tested for rated ambient temperatures, simplifies facility design requirements for rejected heat.

Enclosures - Optional weather protective and sound attenuated enclosures are available.

NFPA - The genset accepts full rated load in a single step in accordance with NFPA 110 for Level 1 systems.

Warranty and service - Backed by a comprehensive warranty and worldwide distributor network.

	Standby rating	Prime rating	Continuous rating	Data sheets
Model	60 Hz kW (kVA)	60 Hz kW (kVA)	60 Hz kW (kVA)	60 Hz
DQCA	600 (750)	545 (681)		D-3352
DQCB	750 (938)	680 (850)		D-3353
DQCC	800 (1000)	725 (906)		D-3354

Generator Set Specifications

Governor regulation class	ISO8528 Part 1 Class G2
Voltage regulation, no load to full load	± 0.5%
Random voltage variation	± 0.5%
Frequency regulation	Isochronous
Random frequency variation	± 0.25%
Radio frequency emissions compliance	IEC 61000-4-2: Level 4 electrostatic discharge IEC 61000-4-3: Level 3 radiated susceptibility

Engine Specifications

Bore	169.9 mm (6.69 in)
Stroke	169.9 mm (6.69 in)
Displacement	23.15 liters (1413 in ³)
Configuration	Cast iron, in line 6 cylinder
Battery capacity	1600 amps minimum at ambient temperature of 0 °C to 10 °C (32 °F to 50 °F)
Battery charging alternator	35 amps
Starting voltage	24 volt, negative ground
Fuel system	Direct injection: number 2 diesel fuel, fuel filter, automatic electric fuel shutoff
Fuel filter	Spin-on fuel filters with water separator
Air cleaner type	Dry replaceable element with restriction indicator
Lube oil filter type(s)	Fleet guard dual venturi spin-on, combination full flow and bypass filters
Standard cooling system	High ambient radiator

Alternator Specifications

Design	Brushless, 4 pole, drip proof, revolving field
Stator	2/3 pitch
Rotor	Single bearing flexible disc
Insulation system	Class H
Standard temperature rise	125 °C Standby at 40 °C ambient
Exciter type	Permanent Magnet Generator (PMG)
Phase rotation	A (U), B (V), C (W)
Alternator cooling	Direct drive centrifugal blower fan
AC waveform Total Harmonic Distortion (THDV)	< 5% no load to full linear load, < 3% for any single harmonic
Telephone Influence Factor (TIF)	< 50 per NEMA MG1-22.43
Telephone Harmonic Factor (THF)	< 3%

Available Voltages

60 Hz Line-Neutral/Line-Line

- | | | | |
|-----------|-----------|-----------|-----------|
| • 110/190 | • 127/220 | • 230/380 | • 277/480 |
| • 115/200 | • 139/240 | • 240/416 | • 347/600 |
| • 120/208 | • 220/380 | • 255/440 | |

Note: Consult factory for other voltages.

Generator Set Options and Accessories

Engine

- 208/240/480 V coolant heater for ambient 4.5 °C (40 °F)
- Fuel/water separator
- Heavy duty air cleaner

Alternator

- 80 °C rise
- 105 °C rise
- 125 °C rise

- 120/240 V anti-condensation heater
- Temperature sensor - alternator bearing RTD

Control panel

- PC2.3
- PC3.3 with MLD
- 120/240 V 100 W control anti-condensation heater
- Ground fault indication
- Remote fault signal package
- Run relay package

- Run time display

Cooling system

- 50 °C ambient

Generator Set Options and Accessories (continued)

Exhaust system

- Industrial grade exhaust silencer (12 to 18 dBA)
- Residential grade exhaust silencer (18 to 25 dBA)
- Critical grade exhaust silencer (25 to 35 dBA)
- Super critical exhaust silencer (35 to 45 dBA)

Generator set

- AC entrance box
- Battery
- Battery rack with hold-down
- Circuit breaker - set mounted
- Remote annunciator panel
- Spring isolators

• 2 year warranty

- 5 year warranty
- 10 year major components warranty

Note: Some options may not be available on all models - consult factory for availability.

PowerCommand 2.3 – Control system



PowerCommand 2.3 control - An integrated generator set control system providing voltage regulation, engine protection, generator protection, operator interface, and isochronous governing (optional).

Control - Provides battery monitoring and testing features and smart-starting control system.

InPower™ - PC based service tool available for detailed diagnostics.

PCCNet RS485 - Network interface (standard) to devices such as remote annunciator for NFPA 110 applications.

Control boards - Potted for environmental protection.

Ambient operation - Suitable for operation in ambient temperatures from -40 °C to +70 °C and altitudes to 13,000 feet (5000 meters).

Prototype tested - UL, CSA, and CE compliant.

AC protection

- AmpSentry protective relay
- Over current warning and shutdown
- Over and under voltage shutdown
- Over and under frequency shutdown
- Over excitation (loss of sensing) fault
- Field overload
- Overload warning
- Reverse kW shutdown
- Reverse Var shutdown
- Short circuit protection

Engine protection

- Overspeed shutdown
- Low oil pressure warning and shutdown
- High coolant temperature warning and shutdown
- Low coolant level warning or shutdown
- Low coolant temperature warning
- High, low and weak battery voltage warning
- Fail to start (over crank) shutdown
- Fail to crank shutdown
- Redundant start disconnect
- Cranking lockout

- Sensor failure indication
- Low fuel level warning or shutdown
- Fuel-in-rupture-basin warning or shutdown

Operator/display panel

- Manual off switch
- 128 x 128 alpha-numeric display with push button access for viewing engine and alternator data and providing setup, controls and adjustments (English or international symbols)
- LED lamps indicating generator set running, not in auto, common warning, common shutdown, manual run mode and remote start
- Suitable for operation in ambient temperatures from -20 °C to +70 °C

Alternator data

- Line-to-Neutral AC volts
- Line-to-Line AC volts
- 3-phase AC current
- Frequency
- kVA, kW, power factor

Engine data

- DC voltage
- Lube oil pressure
- Coolant temperature

Other data

- Generator set model data
- Start attempts, starts, running hours
- Fault history
- RS485 Modbus® interface
- Data logging and fault simulation (requires InPower service tool)
- Total kilowatt hours
- Load profile

Digital governing (optional)

- Integrated digital electronic isochronous governor
- Temperature dynamic governing

Digital voltage regulation

- Integrated digital electronic voltage regulator
- 3-phase Line-to-Line sensing
- Configurable torque matching
- Fault current regulation under single or three phase fault conditions

Control functions

- Time delay start and cool down
- Glow plug control (some models)
- Cycle cranking
- PCCNet interface
- (4) Configurable inputs
- (4) Configurable outputs
- Remote emergency stop
- Battle short mode
- Load shed
- Real time clock with exerciser
- Derate

Options

- Auxiliary output relays (2)
- 120/240 V, 100 W anti-condensation heater
- Remote annunciator with (3) configurable inputs and (4) configurable outputs
- **PMG alternator excitation**
- PowerCommand for Windows® remote monitoring software (direct connect)
- AC output analogue meters
- **PowerCommand 2.3 and 3.3 control with AmpSentry protection**

For further detail on PC 2.3, see document S-1569.

For further detail on PC 3.3, see document S-1570.

Ratings Definitions

Emergency Standby Power (ESP):

Applicable for supplying power to varying electrical loads for the duration of power interruption of a reliable utility source. Emergency Standby Power (ESP) is in accordance with ISO 8528. Fuel Stop power in accordance with ISO 3046, AS 2789, DIN 6271 and BS 5514.

Limited-Time Running Power (LTP):

Applicable for supplying power to a constant electrical load for limited hours. Limited-Time Running Power (LTP) is in accordance with ISO 8528.

Prime Power (PRP):

Applicable for supplying power to varying electrical loads for unlimited hours. Prime Power (PRP) is in accordance with ISO 8528. Ten percent overload capability is available in accordance with ISO 3046, AS 2789, DIN 6271 and BS 5514.

Base Load (Continuous) Power (COP):

Applicable for supplying power continuously to a constant electrical load for unlimited hours. Continuous Power (COP) in accordance with ISO 8528, ISO 3046, AS 2789, DIN 6271 and BS 5514.

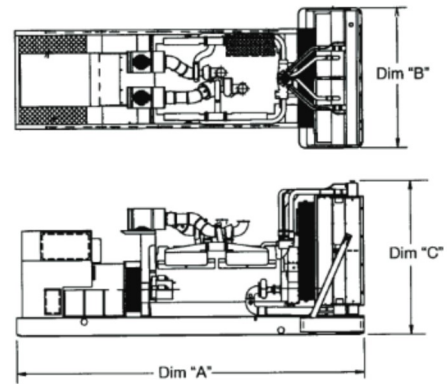

This outline drawing is for reference only. See respective model data sheet for specific model outline drawing number.

Do not use for installation design

Dimensions and Weights with Standard Cooling System

Model	Dim 'A' mm (in.)	Dim 'B' mm (in.)	Dim 'C' mm (in.)	Set weight* dry kg (lbs)	Set weight* wet kg (lbs)
DQCA	4395.4 (173)	1855.5 (73)	2065.7 (81)	6075 (13395)	6337 (13973)
DQCB	4395.4 (173)	1855.5 (73)	2065.7 (81)	6075 (13395)	6337 (13973)
DQCC	4395.4 (173)	1855.5 (73)	2065.7 (81)	6075 (13395)	6337 (13973)





Dimensions and Weights with Optional Cooling System with Seismic Feature Codes L228-2 and/or L225-2

Model	Dim 'A' mm (in.)	Dim 'B' mm (in.)	Dim 'C' mm (in.)	Set weight* dry kg (lbs)	Set weight* wet kg (lbs)
DQCA	4395.4 (173)	1715 (68)	2060.1 (81.1)	6377 (14061)	6518 (14372)
DQCB	4395.4 (173)	1715 (68)	2060.1 (81.1)	6377 (14061)	6518 (14372)
DQCC	4395.4 (173)	1715 (68)	2060.1 (81.1)	6377 (14061)	6518 (14372)

* Weights represent a set with standard features. See outline drawings for weights of other configurations.

Codes and Standards

Codes or standards compliance may not be available with all model configurations – consult factory for availability.

	<p>This generator set is designed in facilities certified to ISO 9001 and manufactured in facilities certified to ISO 9001 or ISO 9002.</p>		<p>The generator set is available listed to UL 2200 for all 60 Hz low voltage models, Stationary Engine Generator Assemblies. The PowerCommand control is Listed to UL 508 - Category NITW7 for U.S. and Canadian usage. Circuit breaker assemblies are UL 489 Listed for 100% continuous operation and also UL 869A Listed Service Equipment.</p>
	<p>The Prototype Test Support (PTS) program verifies the performance integrity of the generator set design. Cummins products bearing the PTS symbol meet the prototype test requirements of NFPA 110 for Level 1 systems.</p>	<p>U.S. EPA</p>	<p>Engine certified to Stationary Emergency U.S. EPA New Source Performance Standards, 40 CFR 60 subpart IIII Tier 2 exhaust emission levels. U.S. applications must be applied per this EPA regulation.</p>
	<p>All low voltage models are CSA certified to product class 4215-01.</p>	<p>International Building Code</p>	<p>The generator set package is available certified for seismic application in accordance with the following International Building Code: IBC2000, IBC2003, IBC2006, IBC2009, and IBC2012.</p>

Warning: Back feed to a utility system can cause electrocution and/or property damage. Do not connect to any building's electrical system except through an approved device or after building main switch is open.

For more information contact your local Cummins distributor or visit power.cummins.com

Our energy working for you.™



Generator Set Data Sheet



Model:	DQCB
Frequency:	60 Hz
Fuel Type:	Diesel
kW Rating:	750 Standby 680 Prime
Emissions Level:	EPA NSPS Stationary Emergency Tier 2

Exhaust Emission Data Sheet:	EDS-1087
Exhaust Emission Compliance Sheet:	EPA-1121
Sound Data Sheet:	MSP-1159
Sound Data Sheet – with Seismic Feature Codes L228-2 (IBC) and/or L225-2 (OSHPD):	MSP-1013
Cooling System Data in various Ambient Conditions:	MCP-248
Cooling System Data in various Ambient Conditions – with Seismic Feature Codes L228-2 (IBC) and/or L225-2 (OSHPD):	MCP-174
Prototype Test Summary Data Sheet:	PTS-160

Fuel Consumption	Standby				Prime				Continuous
	kW (kVA)				kW (kVA)				kW (kVA)
Ratings	750 (938)				680 (850)				
Load	1/4	1/2	3/4	Full	1/4	1/2	3/4	Full	Full
US gph	16.6	28.7	40.3	51.3	15.4	26.5	37.1	47.3	
L/hr	62.7	108.8	152.6	194.1	58.3	100.4	140.6	178.9	

Engine	Standby Rating	Prime Rating	Continuous Rating
Engine manufacturer	Cummins Inc.		
Engine model	QSK23-G7 NR2		
Configuration	Cast Iron, in line, 6 cylinder		
Aspiration	Turbocharged and low temperature after-cooled		
Gross engine power output, kWm (bhp)	910 (1220)	808 (1085)	
BMEP at set rated load, kPa (psi)	2435 (353)	2214 (321)	
Bore, mm (in.)	170 (6.69)		
Stroke, mm (in.)	170 (6.69)		
Rated speed, rpm	1800		
Piston speed, m/s (ft/min)	10.21 (2010)		
Compression ratio	16:1		
Lube oil capacity, L (qt)	102 (108)		
Overspeed limit, rpm	2100		
Regenerative power, kW	93		

Fuel Flow	
Maximum fuel flow, L/hr (US gph)	685 (181)
Maximum fuel inlet restriction, kPa (in Hg)	13.44 (4)
Maximum fuel inlet temperature, °C (°F)	71 (160)

Air	Standby Rating	Prime Rating	Continuous Rating
Combustion air, m ³ /min (scfm)	64 (2242)	62 (2189)	
Maximum air cleaner restriction, kPa (in H ₂ O)	6.2 (25)		
Alternator cooling air, m ³ /min (cfm)	117 (4156)		

Exhaust

Exhaust flow at set rated load, m ³ /min (cfm)	152 (5358)	146 (5147)	
Exhaust temperature, °C (°F)	476 (888)	458 (856)	
Maximum back pressure, kPa (in H ₂ O)	10.1 (40.8)		

Standard Set-Mounted Radiator Cooling (Non-Seismic)

Ambient design, °C (°F)	50 (122)		
Fan load, kW _m (HP)	24 (32)		
Coolant capacity (with radiator), L (US gal)	109.5 (29)		
Cooling system air flow, m ³ /min (scfm)	1069.8 (37779.6)		
Total heat rejection, MJ/min (Btu/min)	32.3 (30655)	29.6 (28065)	
Maximum cooling air flow static restriction, kPa (in H ₂ O)	0.12 (0.5)		
Maximum fuel return line restriction kPa (in Hg)	30.47 (9)		

Optional Set-Mounted Radiator Cooling (with Seismic Feature Codes L228-2 (IBC) and/or L225-2 (OSHPD))

Ambient design, °C (°F)	50 (122)		
Fan load, kW _m (HP)	27 (36)		
Coolant capacity (with radiator), L (US gal)	89 (23.5)		
Cooling system air flow, m ³ /min (scfm)	1252 (44183)		
Total heat rejection, MJ/min (Btu/min)	32.3 (30655)	29.6 (28065)	
Maximum cooling air flow static restriction, kPa (in H ₂ O)	0.12 (0.5)		
Maximum fuel return line restriction, kPa (in Hg)	30.47 (9)		

Optional Heat Exchanger Cooling

Set coolant capacity, L (US gal)			
Heat rejected, jacket water circuit, MJ/min (Btu/min)			
Heat rejected, aftercooler circuit, MJ/min (Btu/min)			
Heat rejected, fuel circuit, MJ/min (Btu/min)			
Total heat radiated to room, MJ/min (Btu/min)			
Maximum raw water pressure, jacket water circuit, kPa (psi)			
Maximum raw water pressure, aftercooler circuit, kPa (psi)			
Maximum raw water pressure, fuel circuit, kPa (psi)			
Maximum raw water flow, jacket water circuit, L/min (US gal/min)			
Maximum raw water flow, aftercooler circuit, L/min (US gal/min)			
Maximum raw water flow, fuel circuit, L/min (US gal/min)			
Minimum raw water flow at 27 °C (80 °F) inlet temp, jacket water circuit, L/min (US gal/min)			
Minimum raw water flow at 27 °C (80 °F) inlet temp, aftercooler circuit, L/min (US gal/min)			
Minimum raw water flow at 27 °C (80 °F) inlet temp, fuel circuit, L/min (US gal/min)			
Raw water delta P at min flow, jacket water circuit, kPa (psi)			

	Standby rating	Prime rating	Continuous rating
Raw water delta P at min flow, aftercooler circuit, kPa (psi)			
Raw water delta P at min flow, fuel circuit, kPa (psi)			
Maximum jacket water outlet temp, °C (°F)			
Maximum aftercooler inlet temp, °C (°F)			
Maximum aftercooler inlet temp at 25 °C (77 °F) ambient, °C (°F)			
Maximum fuel return line restriction, kPa (in Hg)			

Optional Remote Radiator Cooling¹

Set coolant capacity, L (US gal)			
Max flow rate at max friction head, jacket water circuit, L/min (US gal/min)			
Max flow rate at max friction head, aftercooler circuit, L/min (US gal/min)			
Heat rejected, jacket water circuit, MJ/min (Btu/min)			
Heat rejected, aftercooler circuit, MJ/min (Btu/min)			
Heat rejected, fuel circuit, MJ/min (Btu/min)			
Total heat radiated to room, MJ/min (Btu/min)			
Maximum friction head, jacket water circuit, kPa (psi)			
Maximum friction head, aftercooler circuit, kPa (psi)			
Maximum static head, jacket water circuit, m (ft)			
Maximum static head, aftercooler circuit, m (ft)			
Maximum jacket water outlet temp, °C (°F)			
Maximum aftercooler inlet temp at 25 °C (77 °F) ambient, °C (°F)			
Maximum aftercooler inlet temp, °C (°F)			
Maximum fuel flow, L/hr (US gph)			
Maximum fuel return line restriction, kPa (in Hg)			

Weights²

Unit dry weight kgs (lbs)	6075 (13395)
Unit wet weight kgs (lbs)	6337 (13973)

see below drawings for overall shipping weight and dimensions



Notes:

¹ For non-standard remote installations contact your local Cummins representative.

² Weights represent a set with standard features. See outline drawing for weights of other configurations.

Derating Factors

Standby	Engine power available up to 1371 m (4497 ft) at ambient temperatures up to 40 °C (104 °F). Above these elevations, derate at 4.4% per 305 m (1000 ft). Above 40 °C (104 °F), derate 10% per 10 °C (18 °F).
Prime	Engine power available up to 1084 m (3555 ft) at ambient temperatures up to 40 °C (104 °F). Above these elevations, derate at 4.5% per 305 m (1000 ft). Above 40 °C (104 °F), derate 20.9% per 10 °C (18 °F).
Continuous	

Ratings Definitions

Emergency Standby Power (ESP):	Limited-Time Running Power (LTP):	Prime Power (PRP):	Base Load (Continuous) Power (COP):
Applicable for supplying power to varying electrical load for the duration of power interruption of a reliable utility source. Emergency Standby Power (ESP) is in accordance with ISO 8528. Fuel stop power in accordance with ISO 3046, AS 2789, DIN 6271 and BS 5514.	Applicable for supplying power to a constant electrical load for limited hours. Limited-Time Running Power (LTP) is in accordance with ISO 8528.	Applicable for supplying power to varying electrical load for unlimited hours. Prime Power (PRP) is in accordance with ISO 8528. Ten percent overload capability is available in accordance with ISO 3046, AS 2789, DIN 6271 and BS 5514.	Applicable for supplying power continuously to a constant electrical load for unlimited hours. Continuous Power (COP) is in accordance with ISO 8528, ISO 3046, AS 2789, DIN 6271 and BS 5514. No sustained overload capability is available at this rating.

Alternator Data

Voltage	Connection ¹	Temp Rise Degrees C	Duty ²	Single Phase Factor ³	Max surge kVA ⁴	Winding No.	Alternator Data Sheet	Feature Code
480	Wye	125	P		3657	311	ADS-631	BC38-2
600	Wye	125	P		2944	7	ADS-309	B720-2
208-240/416-480	Wye	125/105	S/P		3657	311	ADS-631	BC34-2
200/400	Wye	125/105	S/P		3313	311	ADS-310	BC35-2
400	Wye	125/105	S/P		3313	312	ADS-310	BC36-2
190/380	Wye	125/105	S/P		3657	311	ADS-631	BC37-2
600	Wye	125	S		2944	7	ADS-309	B739-2
280/416	Wye	105/80	S/P		4200	311	ADS-632	B733-2
380	Wye	105/80	S/P		4200	311	ADS-632	BC43-2
480	Wye	105	S		3657	311	ADS-631	B876-2
480	Wye	80	P		3657	311	ADS-631	B879-2
600	Wye	105/80	S/P		3313	7	ADS-310	B603-2
208/416	Wye	80	S		4200	311	ADS-632	BC44-2
480	Wye	80	S		4200	311	ADS-632	B878-2
480	Wye	80	S		4234	312	ADS-312	B660-2
600	Wye	80	S		3866	7	ADS-311	B604-2

Notes:

- Limited single phase capability is available from some three phase rated configurations. To obtain single phase rating, multiply the three phase kW rating by the Single Phase Factor³. All single phase ratings are at unity power factor.
- Standby (S), Prime (P) and Continuous ratings (C).
- Factor for the *Single-phase output from Three phase alternator* formula listed below.
- Maximum rated starting kVA that results in a minimum of 90% of rated sustained voltage during starting.

Formulas for Calculating Full Load Currents:

Three phase output	Single phase output
$\frac{\text{kW} \times 1000}{\text{Voltage} \times 1.73 \times 0.8}$	$\frac{\text{kW} \times \text{SinglePhaseFactor} \times 1000}{\text{Voltage}}$

Warning: Back feed to a utility system can cause electrocution and/or property damage. Do not connect to any building's electrical system except through an approved device or after building main switch is open.

For more information contact your local Cummins distributor or visit power.cummins.com

Our energy working for you.™





PowerCommand® 2.3 Control System



Control System Description

The PowerCommand control system is a microprocessor-based generator set monitoring, metering and control system designed to meet the demands of today's engine driven generator sets. The integration of all control functions into a single control system provides enhanced reliability and performance, compared to conventional generator set control systems. These control systems have been designed and tested to meet the harsh environment in which gensets are typically applied.

Features

- 320 x 240 pixels graphic LED backlight LCD.
- Multiple language support.
- AmpSentry™ protective relay - true alternator overcurrent protection.
- Real time clock for fault and event time stamping.
- Exerciser clock and time of day start/stop.
- Digital voltage regulation. Three phase full wave FET type regulator compatible with either shunt or PMG systems.
- Generator set monitoring and protection.
- 12 and 24 VDC battery operation.
- Modbus® interface for interconnecting to customer equipment.
- Warranty and service. Backed by a comprehensive warranty and worldwide distributor service network.
- Certifications - suitable for use on generator sets that are designed, manufactured, tested and certified to relevant UL, NFPA, ISO, IEC, Mil Std., CE, UKCA and CSA standards.

PowerCommand Digital Genset Control PCC 2300



Description

The PowerCommand generator set control is suitable for use on a wide range of generator sets in non-paralleling applications. The PowerCommand control is compatible with shunt or PMG excitation style. It is suitable for use with reconnectable or non-reconnectable generators, and it can be configured for any frequency, voltage and power connection from 120-600 VAC Line-to-Line.

Power for this control system is derived from the generator set starting batteries. The control functions over a voltage range from 8 VDC to 30 VDC.

Features

- 12 and 24 VDC battery operation.
- Digital voltage regulation - Three phase full wave FET type regulator compatible with either shunt or PMG systems. Sensing is three phase.
- Full authority engine communications (where applicable) - Provides communication and control with the Engine
- due to thermal Control Module (ECM).
- AmpSentry™ protection provides industry-leading alternator overcurrent protection:
 - Time-based generator protection applicable to both line-to-line and line-to-neutral, that can detect an unbalanced fault condition and swiftly react appropriately. Balanced faults can also be detected by AmpSentry and appropriate acted upon.
- Reduces the risk of Arc Flash overload or electrical faults by inverse time protection
- Common harnessing - with higher feature Cummins controls. Allows for easy field upgrades.
- Generator set monitoring - Monitors status of all critical engine and alternator functions.
- Digital genset metering (AC and DC).
- Genset battery monitoring system to sense and warn against a weak battery condition.
- Configurable for single or three phase AC metering.
- Engine starting - Includes relay drivers for starter, Fuel Shut Off (FSO), glow plug/spark ignition power and switch B+ applications.
- Generator set protection – Protects engine and alternator.
- Real time clock for fault and event time stamping.
- Exerciser clock and time of day start/stop.
- Advanced serviceability - using InPower™, a PC-based software service tool.

- Environmental protection - The control system is designed for reliable operation in harsh environments. The main control board is a fully encapsulated module that is protected from the elements.
- Modbus interface for interconnecting to customer equipment.
- Configurable inputs and outputs - Four discrete inputs and four dry contact relay outputs.
- Warranty and service - Backed by a comprehensive warranty and worldwide distributor service network.
- Certifications - Suitable for use on generator sets that are designed, manufactured, tested and certified to relevant UL, NFPA, ISO, IEC, Mil Std., CE and CSA standards.

Base Control Functions

HMI Capability

Operator adjustments - The HMI includes provisions for many set up and adjustment functions.

Generator set hardware data - Access to the control and software part number, generator set rating in kVA and generator set model number is provided from the HMI or InPower.

Data logs - Includes engine run time, controller on time, number of start attempts, total kWh, and load profile (control logs data indicating the operating hours at percent of rated kW load, in 5% increments. The data is presented on the operation panel based on total operating hours on the generator.)

Fault history - Provides a record of the most recent fault conditions with control date and time stamp. Up to 32 events are stored in the control non-volatile memory.

Alternator data

- Voltage (single or three phase Line-to-Line and Line-to-Neutral)
- Current (single or three phase)
- kW, kVar, power factor, kVA (three phase and total)
- Frequency

AmpSentry: 3x current regulation for downstream tripping/motor inrush management. Thermal damage curve (3-phase short) or fixed timer (2 sec for 1- Phase Short or 5 sec for 2-Phase short).

Engine data

- Starting battery voltage
- Engine speed
- Engine temperature
- Engine oil pressure
- Engine oil temperature
- Intake manifold temperature
- Comprehensive Full Authority Engine (FAE) data (where applicable)

Service adjustments - The HMI includes provisions for adjustment and calibration of generator set control functions. Adjustments are protected by a password. Functions include:

Service adjustments (continued)

- Engine speed governor adjustments
- Voltage regulation adjustments
- Cycle cranking
- Configurable fault set up
- Configurable output set up
- Meter calibration
- Display language and units of measurement

Engine Control

SAE-J1939 CAN interface to full authority ECMs (where applicable). Provides data swapping between genset and engine controller for control, metering and diagnostics.

12 VDC/24 VDC battery operations - PowerCommand will operate either on 12 VDC or 24 VDC batteries.

Temperature dependent governing dynamics (with electronic governing) - modifies the engine governing control parameters as a function of engine temperature. This allows the engine to be more responsive when warm and more stable when operating at lower temperature levels.

Isochronous governing - (where applicable) Capable of controlling engine speed within +/-0.25% for any steady state load from no load to full load. Frequency drift will not exceed +/-0.5% for a 33 °C (60 °F) change in ambient temperature over an 8 hour period.

Droop electronic speed governing - Control can be adjusted to droop from 0 to 10% from no load to full load.

Remote start mode - It accepts a ground signal from remote devices to automatically start the generator set and immediately accelerate to rated speed and voltage. The remote start signal will also wake up the control from sleep mode. The control can incorporate a time delay start and stop.

Remote and local emergency stop - The control accepts a ground signal from a local (genset mounted) or remote (facility mounted) emergency stop switch to cause the generator set to immediately shut down. The generator set is prevented from running or cranking with the switch engaged. If in sleep mode, activation of either emergency stop switch will wakeup the control.

Sleep mode - The control includes a configurable low current draw state to minimize starting battery current draw when the genset is not operating. The control can also be configured to go into a low current state while in auto for prime applications or applications without a battery charger.

Engine starting - The control system supports automatic engine starting. Primary and backup start disconnects are achieved by one of two methods: magnetic pickup or main alternator output frequency. The control also supports configurable glow plug control when applicable.

Cycle cranking - Is configurable for the number of starting cycles (1 to 7) and duration of crank and rest periods. Control includes starter protection algorithms to prevent the operator from specifying a starting sequence that might be damaging.

Time delay start and stop (cooldown) - Configurable for time delay of 0-300 seconds prior to starting after receiving a remote start signal and for time delay of 0-600 seconds prior to shut down after signal to stop in normal operation modes. Default for both time delay periods is 0 seconds.

Alternator Control

The control includes an integrated three phase Line-to-Line sensing voltage regulation system that is compatible with shunt or PMG excitation systems. The voltage regulation system is a three phase full wave rectified and has an FET output for good motor starting capability.

Major system features include:

Digital output voltage regulation - Capable of regulating output voltage to within +/-1.0% for any loads between no load and full load. Voltage drift will not exceed +/- 1.5% for a 40 °C (104 °F) change in temperature in an eight hour period. On engine starting or sudden load acceptance, voltage is controlled to a maximum of 5% overshoot over nominal level. The automatic voltage regulator feature can be disabled to allow the use of an external voltage regulator.

Droop voltage regulation - Control can be adjusted to droop from 0-10% from no load to full load.

Torque-matched V/Hz overload control - The voltage roll-off set point and rate of decay (i.e. the slope of the V/Hz curve) is adjustable in the control.

Fault current regulation - PowerCommand will regulate the output current on any phase to a maximum of three times rated current under fault conditions for both single phase and three phase faults. In conjunction with a permanent magnet generator, it will provide three times rated current on all phases for motor starting and short circuit coordination purpose.

Protective Functions

On operation of a protective function the control will indicate a fault by illuminating the appropriate status LED on the HMI, as well as display the fault code and fault description on the LCD. The nature of the fault and time of occurrence are logged in the control. The service manual and InPower service tool provide service keys and procedures based on the service codes provided.

Protective functions include:

Battle Short Mode

When enabled and the *battle short* switch is active, the control will allow some shutdown faults to be bypassed. If a bypassed shutdown fault occurs, the fault code and description will still be annunciated, but the genset will not shutdown. This will be followed by a *fail to shutdown* fault. Emergency stop shutdowns and others that are critical for proper operation are not bypassed. Please refer to the control application guide or manual for list of these faults.

Derate

The derate function reduces output power of the genset in response to a fault condition. If a derate command occurs while operating on an isolated bus, the control will issue commands to reduce the load on the genset via contact closures or modbus.

Configurable Alarm and Status Inputs

The control accepts up to four alarm or status inputs (configurable contact closed to ground or open) to indicate a configurable (customer-specified) condition. The control is programmable for warning, shutdown or status indication and for labeling the input.

Emergency Stop

Annunciated whenever either emergency stop signal is received from external switch.

Full Authority Electronic Engine Protection

Engine fault detection is handled inside the engine ECM. Fault information is communicated via the SAE-J1939 data link for annunciation in the HMI.

General Engine Protection

Low and high battery voltage warning - Indicates status of battery charging system (failure) by continuously monitoring battery voltage.

Weak battery warning - The control system will test the battery each time the generator set is signaled to start and indicate a warning if the battery indicates impending failure.

Fail to start (overcrank) shutdown - The control system will indicate a fault if the generator set fails to start by the completion of the engine crank sequence.

Fail to crank shutdown - Control has signaled starter to crank engine but engine does not rotate.

Cranking lockout - The control will not allow the starter to attempt to engage or to crank the engine when the engine is rotating.

Alternator Protection

AmpSentry protective relay - A comprehensive monitoring and control system integral to the PowerCommand Control System that guards the electrical integrity of the alternator and power system by providing protection against a wide array of fault conditions in the generator set or in the load. It also provides single and three phase fault current regulation so that downstream protective devices have the maximum current available to quickly clear fault conditions without subjecting the alternator to potentially catastrophic failure conditions. Thermal damage curve (3-Phase short) or fixed timer (2 sec for 1-Phase short, 5 sec for 2-Phase short). See document R1053 for a full-size time over current curve.

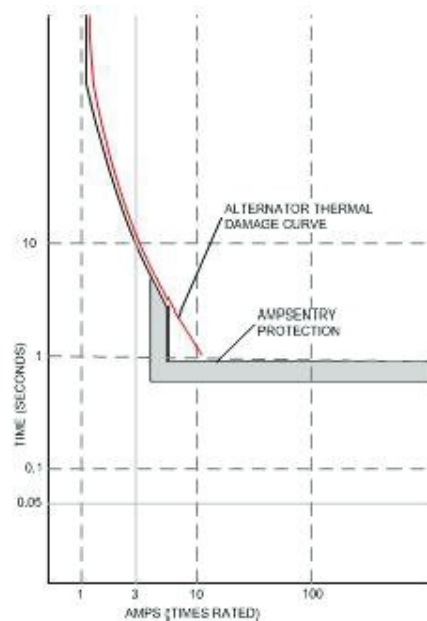

AmpSentry Maintenance Mode (AMM) - Instantaneous tripping, if AmpSentry Maintenance mode is active (50mS response to turn off AVR excitation/shutdown genset) for arc flash reduction when personnel are near genset.

High AC voltage shutdown (59) - Output voltage on any phase exceeds preset values. Time to trip is inversely proportional to amount above threshold. Values adjustable from 105-125% of nominal voltage, with time delay adjustable from 0.1-10 seconds. Default value is 110% for 10 seconds.

Low AC voltage shutdown (27) - Voltage on any phase has dropped below a preset value. Adjustable over a range of 50-95% of reference voltage, time delay 2-20 seconds. Default value is 85% for 10 seconds. Function tracks reference voltage. Control does not nuisance trip when voltage varies due to the control directing voltage to drop, such as during a V/Hz roll-off during synchronizing.

Under frequency shutdown (81 u) - Generator set output frequency cannot be maintained. Settings are adjustable from 2-10 Hz below reference governor set point, for a 5- 20 second time delay. Default: 6 Hz, 10 seconds.

Under frequency protection is disabled when excitation is switched off, such as when engine is operating in idle speed mode.

Over frequency shutdown/warning (81 o) - Generator set is operating at a potentially damaging frequency level. Settings are adjustable from 2-10 Hz above nominal governor set point for a 1-20 second time delay. Default: 6 Hz, 20 seconds, disabled.

Overcurrent warning/shutdown - Thresholds and time delays are configurable. Implementation of the thermal damage curve with instantaneous trip level calculated based on current transformer ratio and application power rating.

Loss of sensing voltage shutdown - Shutdown of generator set will occur on loss of voltage sensing inputs to the control.

Field overload shutdown - Monitors field voltage to shutdown generator set when a field overload condition occurs.

Over load (kW) warning - Provides a warning indication when engine is operating at a load level over a set point.

Adjustment range: 80-140% of application rated kW, 0-120 second delay. Defaults: 105%, 60 seconds.

Reverse power shutdown (32) - Adjustment range: 5-20% of standby kW rating, delay 1-15 seconds. Default: 10%, 3 seconds.

Reverse Var shutdown - Shutdown level is adjustable: 15-50% of rated Var output, delay 10-60 seconds. Default: 20%, 10 seconds.

Short circuit protection - Output current on any phase is more than 175% of rating and approaching the thermal damage point of the alternator. Control includes algorithms to protect alternator from repeated over current conditions over a short period of time.

Field Control Interface

Input signals to the PowerCommand control include:

- Coolant level (where applicable)
- Fuel level (where applicable)
- Remote emergency stop
- Remote fault reset
- Remote start
- Battleshort
- Rupture basin
- Start type signal
- Configurable inputs - Control includes (4) input signals from customer discrete devices that are configurable for warning, shutdown or status indication, as well as message displayed

Output signals from the PowerCommand control include:

- Load dump signal: Operates when the generator set is in an overload condition.
- Delayed off signal: Time delay based output which will continue to remain active after the control has removed the run command. Adjustment range: 0 – 120 seconds. Default: 0 seconds.

- Configurable relay outputs: Control includes (4) relay output contacts (3 A, 30 VDC). These outputs can be configured to activate on any control warning or shutdown fault as well as ready to load, not in auto, common alarm, common warning and common shutdown.

- Ready to load (generator set running) signal: Operates when the generator set has reached 90% of rated speed and voltage and latches until generator set is switched to off or idle mode.

Communications Connections Include:

- PC tool interface: This RS-485 communication port allows the control to communicate with a personal computer running InPower software.

- Modbus RS-485 port: Allows the control to communicate with external devices such as PLCs using Modbus protocol.

Note - An RS-232 or USB to RS-485 converter is required for communication between PC and control.

- Networking: This RS-485 communication port allows connection from the control to the other Cummins products.

Mechanical Drawings

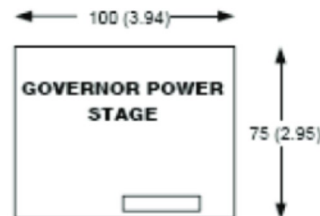
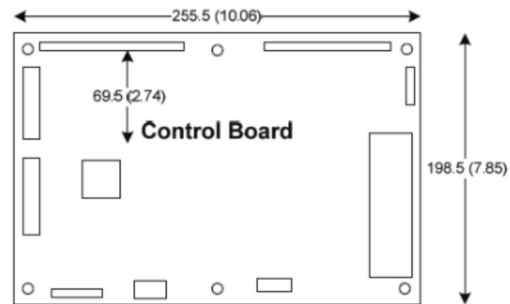

PowerCommand Human Machine Interface HMI320



Description

This control system includes an intuitive operator interface panel that allows for complete genset control as well as system metering, fault annunciation, configuration and diagnostics. The interface includes five genset status LED lamps with both internationally accepted symbols and English text to comply with customer's needs. The interface also includes an LED backlit LCD display with tactile feel soft-switches for easy operation and screen navigation. It is configurable for units of measurement and has adjustable screen contrast and brightness.

The *run/off/auto* switch function is integrated into the interface panel.

All data on the control can be viewed by scrolling through screens with the navigation keys. The control displays the current active fault and a time-ordered history of the five previous faults.

Features

- LED indicating lamps:
 - Genset running
 - Remote start
 - Not in auto
 - Shutdown
 - Warning
 - Auto
 - Manual and stop
- 320 x 240 pixels graphic LED backlight LCD.
- Four tactile feel membrane switches for LCD defined operation. The functions of these switches are defined dynamically on the LCD.
- Seven tactile feel membrane switches dedicated screen navigation buttons for up, down, left, right, ok, home and cancel.
- Six tactile feel membrane switches dedicated to control for auto, stop, manual, manual start, fault reset and lamp test/panel lamps.

- Two tactile feel membrane switches dedicated to control of circuit breaker (where applicable).
- Allows for complete genset control setup.
- Certifications: Suitable for use on generator sets that are designed, manufactured, tested and certified to relevant UL, NFPA, ISO, IEC, Mil Std., CE and CSA standards.
- LCD languages supported: English, Spanish, French, German, Italian, Greek, Dutch, Portuguese, Finnish, Norwegian, Danish, Russian and Chinese Characters.

Communications connections include:

- PC tool interface - This RS-485 communication port allows the HMI to communicate with a personal computer running InPower.
- This RS-485 communication port allows the HMI to communicate with the main control board.

Mechanical Drawing

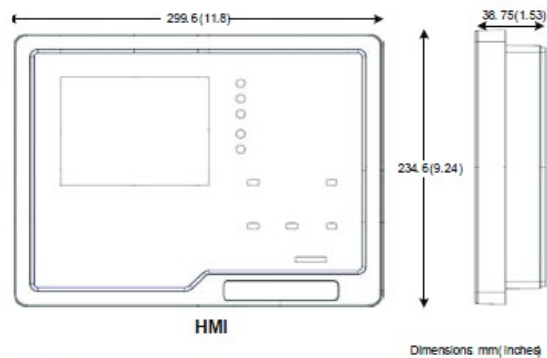

Software

InPower (beyond 6.5 version) is a PC-based software service tool that is designed to directly communicate to PowerCommand generator sets and transfer switches, to facilitate service and monitoring of these products.

Environment

The control is designed for proper operation without recalibration in ambient temperatures from -40 °C to +70 °C (-40 °F to 158 °F) and for storage from -55 °C to +80 °C (-67 °F to 176 °F). Control will operate with humidity up to 95%, non-condensing.

The HMI is designed for proper operation in ambient temperatures from -20 °C to +70 °C (-4 °F to 158 °F) and for storage from -30 °C to +80 °C (-22 °F to 176 °F).

The control board is fully encapsulated to provide superior resistance to dust and moisture. Display panel has a single membrane surface, which is impervious to effects of dust, moisture, oil and exhaust fumes. This panel uses a sealed membrane to provide long reliable service life in harsh environments.

The control system is specifically designed and tested for resistance to RFI/EMI and to resist effects of vibration to provide a long reliable life when mounted on a generator set. The control includes transient voltage surge suppression to provide compliance to referenced standards.

Certifications

PowerCommand meets or exceeds the requirements of the following codes and standards:

- NFPA 110 for level 1 and 2 systems.
- ISO 8528-4: 1993 compliance, controls and switchgear.
- CE marking: The CE marking is only valid when equipment is used in a fixed installation application. Material compliance declaration is available upon request.
- UKCA marking: The UKCA marking is only valid when equipment is used in a fixed installation application. Material compliance declaration is available upon request.
- EN50081-1,2 residential/light industrial emissions or industrial emissions.
- EN50082-1,2 residential/light industrial or industrial susceptibility.
- ISO 7637-2, level 2; DC supply surge voltage test.
- Mil Std 202C, Method 101 and ASTM B117: Salt fog test.
- UL 6200 recognized and suitable for use on UL 2200 Listed generator sets.
- CSA C282-M1999 compliance
- CSA 22.2 No. 14 M91 industrial controls.
- PowerCommand control systems and generator sets are designed and manufactured in ISO 9001 certified facilities.

Warranty

All components and subsystems are covered by an express limited one year warranty. Other optional and extended factory warranties and local distributor maintenance agreements are available.



For more information contact your local Cummins distributor
or visit power.cummins.com

Our energy working for you.™





Alternator Data Sheet Frame Size: S6L1D-D4

Characteristics								
Weights:		No of Bearings:	1-bearing		2-bearing			
		Stator assembly:	2037 lb	924 kg	2037 lb	924 kg		
		Rotor assembly:	1764 lb	800 kg	1671 lb	758 kg		
		Complete assembly:	4306 lb	1953 kg	4475 lb	2030 kg		
Maximum speed:		2250 rpm						
Excitation current:		Full load:	2.9 Amps					
		No load:	0.87 Amps (Wdg 311/312), 0.78 Amps (Wdg 07)					
Insulation system:		Class H throughout						
3 Ø Ratings (0.8 power factor)		60 Hz (winding no)						
			120/208 <u>240/416</u> (311/312)	127/220 <u>254/440</u> (311/312)	133/230 <u>266/460</u> (311/312)	139/240 <u>277/480</u> (311/312)	<u>120/240</u> <u>Delta</u> (311/312)	<u>347/600</u> (07)
150° C rise ratings	@ 40° C	kW	870	900	910	950	870	900
		kVA	1088	1125	1138	1188	1088	1125
125° C rise ratings	@ 40° C	kW	820	850	860	900	820	850
		kVA	1025	1063	1075	1125	1025	1063
105° C rise ratings	@ 40° C	kW	732	772	800	820	732	770
		kVA	915	965	1000	1025	915	963
80° C rise ratings	@ 40° C	kW	632	680	700	720	632	720
		kVA	790	850	875	900	790	900
Reactances (per unit ± 10%)			120/208 <u>240/416</u> (311/312)	127/220 <u>254/440</u> (311/312)	133/230 <u>266/460</u> (311/312)	139/240 <u>277/480</u> (311/312)	<u>120/240</u> <u>Delta</u> (311/312)	<u>347/600</u> (07)
(Based on full load at 125° C rise rating)								
Synchronous			2.29	2.12	1.96	1.88	2.29	1.87
Transient			0.16	0.15	0.14	0.14	0.16	0.13
Subtransient			0.13	0.12	0.11	0.11	0.13	0.10
Negative sequence			0.2	0.18	0.17	0.16	0.2	0.14
Zero sequence			0.05	0.05	0.05	0.04	0.05	0.03
Motor starting			120/208 <u>240/416</u> (311/312)	127/220 <u>254/440</u> (311/312)	133/230 <u>266/460</u> (311/312)	139/240 <u>277/480</u> (311/312)	<u>120/240</u> <u>Delta</u> (311/312)	<u>347/600</u> (07)
Maximum kVA (90% sustained voltage)			3657	3657	3657	3657	3657	3657
Time constants (sec)			120/208 <u>240/416</u> (311/312)	127/220 <u>254/440</u> (311/312)	133/230 <u>266/460</u> (311/312)	139/240 <u>277/480</u> (311/312)	<u>120/240</u> <u>Delta</u> (311/312)	<u>347/600</u> (07)
Transient			0.088	0.088	0.088	0.088	0.088	0.091
Subtransient			0.0149	0.0149	0.0149	0.0149	0.0149	0.013
Open circuit			3.63	3.63	3.63	3.63	3.63	3.352
DC			0.0246	0.0246	0.0246	0.0246	0.0246	0.021
Windings (@22° C)			120/208 <u>240/416</u> (311/312)	127/220 <u>254/440</u> (311/312)	133/230 <u>266/460</u> (311/312)	139/240 <u>277/480</u> (311/312)	<u>120/240</u> <u>Delta</u> (311/312)	<u>347/600</u> (07)
Stator resistance (L-L Ohms)			0.0022	0.0022	0.0022	0.0022	0.0022	0.007
Rotor resistance (Ohms)			1.82	1.82	1.82	1.82	1.82	1.82
Number of leads			12/6	12/6	12/6	12/6	12/6	6

* Parallel Star connection only available with Wdg 311



Prototype Test Supported Emergency/Standby Generator Sets Certification

Cummins Power Generation certifies that its commercial generator sets bearing the Prototype Test Supported (PTS) seal have been subjected to a design and development process that includes extensive prototype testing and evaluation. A PTS production model is engineered and manufactured according to documentation developed through comprehensive research, design and design verification.

Design verification is based on tests of preproduction prototype models manufactured specifically for prototype test purposes and not sold as new equipment. To be certified as a PTS model, the generator set must satisfy these prerequisites:

DESIGN - The PTS certified generator set must be designed specifically for emergency/standby applications that require high reliability and rapid response.

PROTOTYPE TESTING - Design suitability of the PTS certified generator set must be proven by tests on preproduction prototype models. The prototype test program is intended to:

1. Confirm the engine and generator have reserve capacity beyond rating to minimize the potential of damage or shutdown during steady state or transient loading conditions, including momentary overloads.
2. Demonstrate generator set, controls and accessories capability to perform reliably and compatibly in service during disturbances common in actual load circuits.
3. Verify the integrity of the generator and excitation system insulation systems and electrical components to withstand heating under rated load and transient overcurrent conditions.
4. Evaluate generator set mechanical and electrical strength to perform without damage during abnormal operating conditions, such as short circuits or out-of-phase paralleling. While operating at rated load, the generator set must be subjected to several 3-phase short circuits of 20 second duration. After the tests, the generator set is inspected to verify that no electrical or mechanical damage was incurred by any components.
5. Determine by endurance testing that no resonance conditions exist in the generator set or accessories that will cause premature failure of components on production units.
6. Investigate and identify failure modes to minimize the risk of any single component failure or human error that could lead to lack of essential electrical supply.
7. Provide a margin of safety, by actual trials, between the generator set component design and protection systems so that the components are not damaged before the protective devices activate a shutdown.

DOCUMENTATION AND SOFTWARE - The PTS certified generator set must be documented in a single drawing package with all components identified with Cummins Power Generation part numbers. A PTS test certificate must be created for each PTS generator set certifying the PTS testing performed.

QUALITY ASSURANCE - Engineering drawings, specifications and test requirements for a PTS certified generator set must be classified by components and assembly quality characteristics. A component and process inspection and test plan must be developed and maintained to measure product conformance to documentation requirements.

PRODUCTION MODEL TESTING - PTS certified generator sets must be subjected to complete production tests that demonstrate conformance to specifications at all rated conditions, including start-up, full load pickup and a performance run at full rated load and power factor.



Prototype Test Support (PTS) 60 Hz test summary



Generator set models	Representative prototype
600DQCA	Model: 800DQCC
800DQCC	Alternator: HC6H
750DQCB	Engine: QSK23-G7 NR2
	Rated voltage: 480 V

The following summarizes prototype testing conducted on the designated representative prototype of the specified models. This testing is conducted to verify the complete generator set electrical and mechanical design integrity. Prototype testing is conducted only on generator sets not sold as new equipment.

<p>Maximum surge power: 833 kW The generator set was evaluated to determine the stated maximum surge power.</p> <p>Torsional analysis and testing: The generator set was tested to verify that the design is not subjected to harmful torsional stresses. A spectrum analysis of the transducer output was conducted over the speed range of 1350 to 1950 RPM.</p> <p>Cooling system: 50 °C ambient 0.50 in H₂O restriction The cooling system was tested to determine ambient temperature and static restriction capabilities. The test was performed at full rated load in elevated ambient temperature under stated static restriction conditions.</p> <p>Durability: The generator set was subjected to a minimum 500 hour endurance test operating at variable load up to the standby rating based upon MIL-STD-705 to verify structural soundness and durability of the design.</p> <p>Electrical and mechanical strength: The generator set was tested to several single phase and three phase faults to verify that the generator can safely withstand the forces associated with short circuit conditions. The generator set was capable of producing full rated output at the conclusion of the testing.</p>	<p>Steady state performance: The generator set was tested to verify steady state operating performance was within the specified maximum limits.</p> <p>Voltage regulation: ± 0.50% Random voltage variation: ± 0.50% Frequency regulation: Isochronous Random frequency variation: ± 0.25%</p> <p>Transient performance: The generator set was tested with the standard alternator to verify single step loading capability as required by NFPA 110. Voltage and frequency response on load: addition and rejection were evaluated. The following results were recorded at 0.8 PF:</p> <p><u>Full load acceptance:</u></p> <p>Voltage dip: 30.0% Recovery time: 2.3 seconds Frequency dip: 9.3% Recovery time: 3.9 seconds</p> <p><u>Full load rejection:</u></p> <p>Voltage rise: 23.7% Recovery time: 2.6 seconds Frequency rise: 4.6% Recovery time: 3.4 seconds</p> <p>Harmonic analysis: Distortion percentage per MIL (per MIL-STD-705B, Method 601.4)</p> <table border="1"> <thead> <tr> <th rowspan="2">Harmonic</th> <th colspan="2">Line to Line</th> <th colspan="2">Line to Neutral</th> </tr> <tr> <th>No load</th> <th>Full load</th> <th>No load</th> <th>Full load</th> </tr> </thead> <tbody> <tr> <td>3</td> <td>0.036</td> <td>0.245</td> <td>0.093</td> <td>0.169</td> </tr> <tr> <td>5</td> <td>0.083</td> <td>2.081</td> <td>0.112</td> <td>2.171</td> </tr> <tr> <td>7</td> <td>0.824</td> <td>0.609</td> <td>0.820</td> <td>0.597</td> </tr> <tr> <td>9</td> <td>0.023</td> <td>0.042</td> <td>0.021</td> <td>0.074</td> </tr> <tr> <td>11</td> <td>0.600</td> <td>0.355</td> <td>0.613</td> <td>0.397</td> </tr> <tr> <td>13</td> <td>0.307</td> <td>0.300</td> <td>0.295</td> <td>0.308</td> </tr> <tr> <td>15</td> <td>0.009</td> <td>0.017</td> <td>0.009</td> <td>0.094</td> </tr> </tbody> </table>	Harmonic	Line to Line		Line to Neutral		No load	Full load	No load	Full load	3	0.036	0.245	0.093	0.169	5	0.083	2.081	0.112	2.171	7	0.824	0.609	0.820	0.597	9	0.023	0.042	0.021	0.074	11	0.600	0.355	0.613	0.397	13	0.307	0.300	0.295	0.308	15	0.009	0.017	0.009	0.094
Harmonic	Line to Line		Line to Neutral																																										
	No load	Full load	No load	Full load																																									
3	0.036	0.245	0.093	0.169																																									
5	0.083	2.081	0.112	2.171																																									
7	0.824	0.609	0.820	0.597																																									
9	0.023	0.042	0.021	0.074																																									
11	0.600	0.355	0.613	0.397																																									
13	0.307	0.300	0.295	0.308																																									
15	0.009	0.017	0.009	0.094																																									

1200 amp breaker

see below drawings for overall shipping weight and dimensions

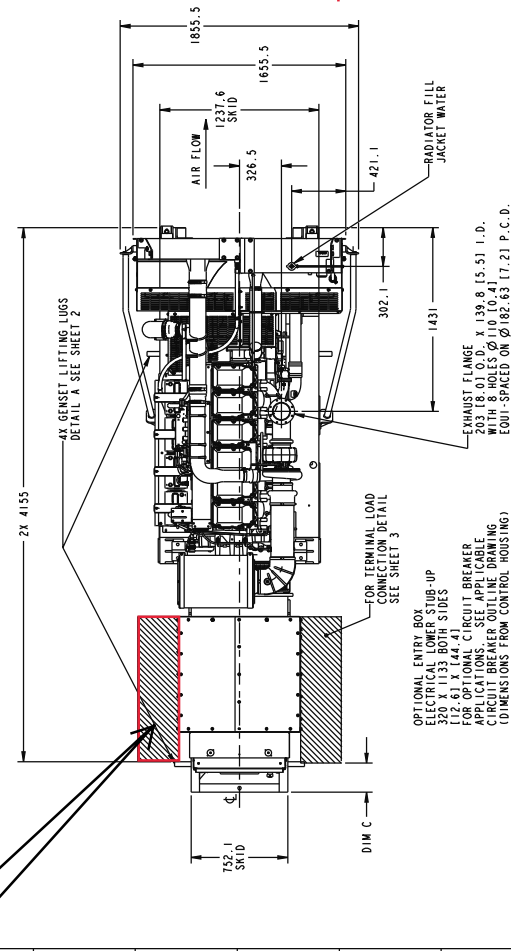

- NOTES:
1. DIMENSIONS SHOWN IN [] BRACKETS ARE INCHES.
 2. FUEL INLET HOSE--1650 (65) LONG WITH 1"-11.5 NPT EXTERNAL FITTING.
 3. FUEL RETURN HOSE--2000 (79) LONG WITH 1"-11.5 NPT EXTERNAL FITTING.
 4. GENSET SHIPPED FILLED WITH ENGINE OIL.
 5. ALL DIMENSIONS ARE REFERENCE, UNLESS SPECIFICALLY TOLERANCED.

C OF G AND WEIGHT TABLE, FOR REFERENCE ONLY

GEN FRAME SIZE	DIM A C OF G	DIM B C OF G	DIM C	GENSET WT W/O COOLANT KGS	GENSET WT W/O COOLANT LBS
S&D	2025 (79.7)	767 (30.2)	227	606.3	1336.7
S&E	2064 (81.2)	767 (30.2)	107	622.5	1372.6
				6487	14304

AIR CLEANER REFERENCE TABLE

AIR CLEANER OPTION	DIM D HEIGHT
STANDARD AIR CLEANER	1867 (74)
HEAVY DUTY AIR CLEANER	2479 (97.6)

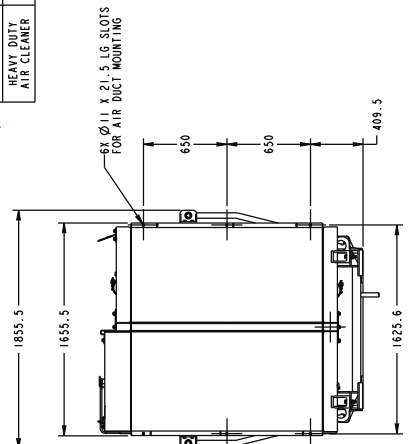

LAST DIMENSION LETTER USED: THIS PART IS SIMILAR TO:

UNLESS OTHERWISE SPECIFIED, THE FOLLOWING SHALL APPLY:

UNIT OF MEASUREMENT:

SCALE:

DATE:

DESIGN:

REVISIONS:

APPROVED:

DATE:

GENSET

Cummins Inc.

DIMENSIONS ARE IN MILLIMETERS SIZE: A1 (SCALE: 1:1)

DRAWING HAS TOLERANCING PER:

ASME Y14.5-2009

GENSET

GROUP PERMANENT

RADIATOR END VIEW

ALTERNATOR MOUNTED CONTROL

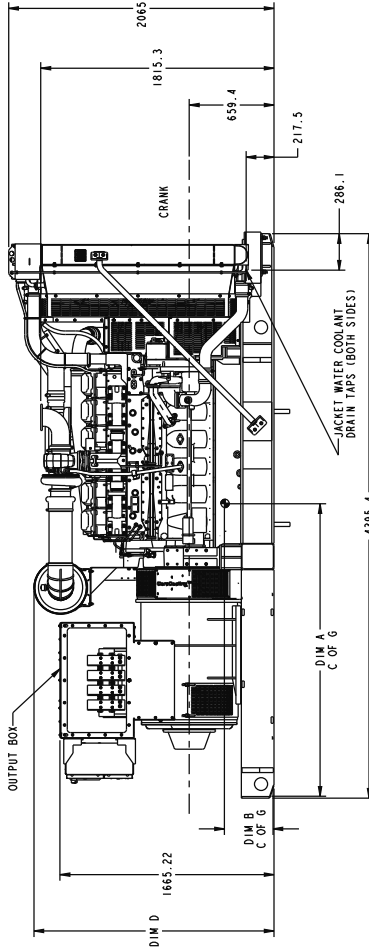

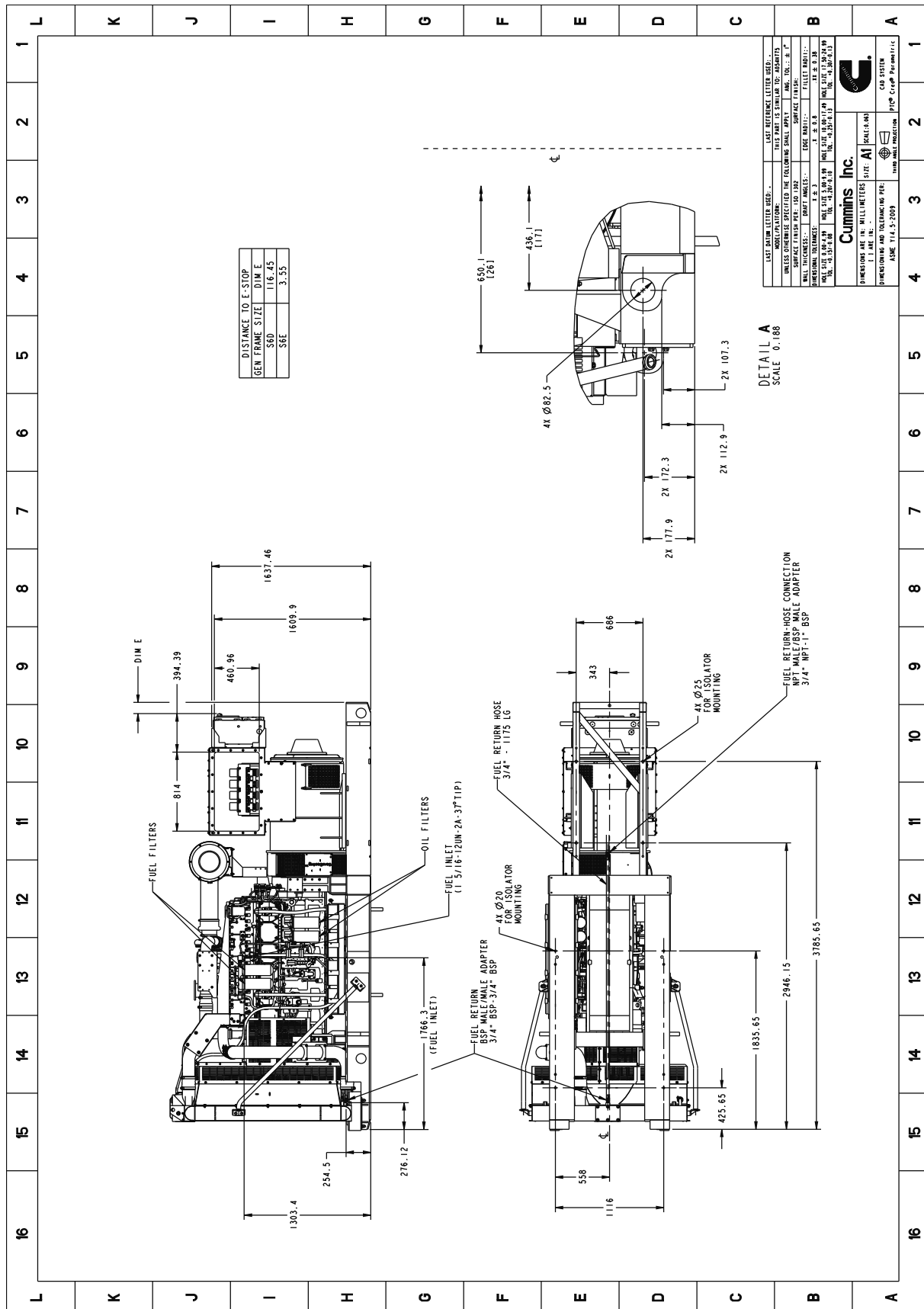

LAST DIMENSION LETTER USED -		LAST REFERENCE LETTER USED -	
MULTIPLICATION:		THIS PART IS SIMILAR TO: ADAPTOR	
UNLESS OTHERWISE SPECIFIED, THE FOLLOWING SHALL APPLY:		ANG. UNITS: °, P	
MATERIAL: 304 SS		FINISH: POLISHED	
WALL THICKNESS: .0075		FILLER METAL: 304 SS	
DRAFT ANGLES: 1:2		EDGE RADIUS: .125 R	
DIMENSIONAL TOLERANCES: ± .005		TOLERANCES UNLESS OTHERWISE SPECIFIED: ± .005	
MATERIAL SPECIFICATION: 304 SS (UNS 30400)		CUMMINS INC.	
DIMENSIONS ARE IN MILLIMETERS		SIZE: A1 (SCALE: 1:1)	
DIMENSIONS ARE TO UNLESS OTHERWISE SPECIFIED		CUMMINS INC.	
ASME Y14.5-2009		CUMMINS INC.	

DETAIL A
SCALE 0.188

Part Number: A062A609 Part Revision: C
Part Name: OUTLINE, GENSET
Drawing Category: Detail State: Released

This document (and the information shown thereon) is Confidential and Proprietary and shall not be disclosed to others in hard copy or electronic form, reproduced by any means, or used for any purpose without written consent of Cummins Inc.

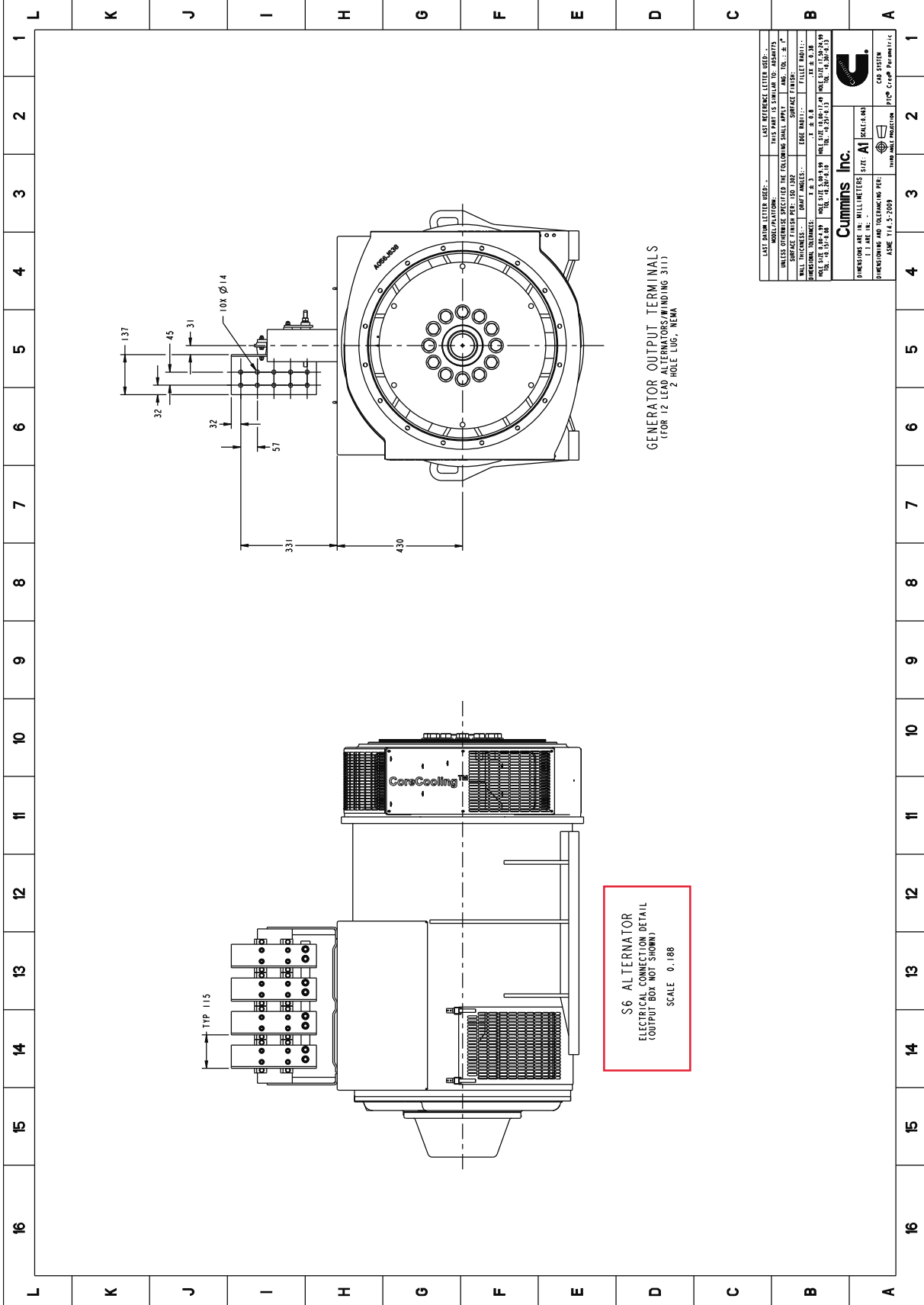

GENERATOR OUTPUT TERMINALS
(FOR 12 LEAD ALTERNATORS/WINDING 311)
2 HOLE LUG, NEMA

S6 ALTERNATOR
ELECTRICAL CONNECTION DETAIL
(OUTPUT BOX NOT SHOWN)
SCALE 0.188

LAST DIMENSION LETTER USED:	LAST REFERENCE LETTER USED:
MODIFICATIONS:	THIS PART IS SIMILAR TO: PART NO. 100.12.5.7
UNLESS OTHERWISE NOTED, ALL DIMENSIONS ARE TO BE TAKEN FROM THE SURFACE UNLESS OTHERWISE SPECIFIED.	
FINISH:	SEE DRAWING
WALL THICKNESS:	SEE DRAWING
DIMENSIONAL TOLERANCES:	FRACTIONS: ± 0.005 DECIMALS: ± 0.010 ANGLES: ± 0.1°
UNLESS OTHERWISE SPECIFIED, ALL DIMENSIONS ARE TO BE TAKEN FROM THE SURFACE UNLESS OTHERWISE SPECIFIED.	
Cummins Inc.	
DIMENSIONS ARE IN MILLIMETERS UNLESS OTHERWISE SPECIFIED.	SCALE: 0.188
DRAWING AND DIMENSIONS PER:	DATE: 11/14/00
ASME Y14.5-2000	3D MODEL PRODUCTION
	3D MODEL PRODUCTION

Part Number: A062A609 Part Revision: C
Part Name: OUTLINE, GENSET
Drawing Category: Detail State: Released Sheet 3 of 4

This document (and the information shown thereon) is Confidential and Proprietary and shall not be disclosed to others in hard copy or electronic form, reproduced by any means, or used for any purpose without written consent of Cummins Inc.

Circuit Breakers



Description

This data sheet provides circuit breaker manufacturer part numbers and specifications. The circuit breaker box description is the rating of that breaker box installation on a Cummins® generator. Please refer to the website of the circuit breaker manufacturer for breaker specific ratings and technical information.

Applicable Models

Engine	Models			
QSK23-G7	DQCA	DQCB	DQCC	
QST30-G5	DQFAA	DQFAB	DQFAC	DQFAD
QST30-G17	DQFAH			
QSK50-G5	DQGAE	DQGAF		
QSK50-G4	DQGAA	DQGAB		
QSK50-G8	DQGAS			
QSK60-G6	DQKAA	DQKAB	DQKAD	DQKAE
QSK60-G14	DQKAF			
QSK60-G17	DQKAM			

Instructions

1. Locate the circuit breaker feature code or part number and use the charts below to find the corresponding manufacturer circuit breaker catalog number.
2. Use the first letter of the circuit breaker catalog number to determine the "frame" of the breaker. If the first letter is an "N", use the second letter. Then follow the corresponding website link from the table below to find the breaker catalog number description.

Please refer to the catalog numbering systems page, which is given in the chart, to understand the nomenclature of the catalog number.

Frame	Catalog Name*	Catalog Number description pages
P and R	0612CT0101 http://www.schneiderelectric.us/en/download/document/0612CT0101/	16-17
L	0611CT1001 http://www.schneiderelectric.us/en/download/document/0611CT1001/	8-9
MasterPact NT/NW	http://www.schneider-electric.us/en/faqs/FA231180/	Please refer to PLS007 Rev 25

*The following link may also be used to search specifically by the breaker part number or for the catalog name listed above.

<http://products.schneider-electric.us/technical-library/>

3. Search the catalog by using the first 3 letters of the breaker catalog number and the first 5 numbers to find information such as trip curves, accessories, and dimensional details regarding the circuit breaker.

*If the catalog number starts with "N", skip the N and begin your search with the second letter.

*If the first 3 letters are "PJP," the search will not work. You will need to start with just "PJ" and use the description pages to obtain the information you are looking for on the "PJP."

Example

After finding your circuit breaker catalog number to be "PJL36120U33EACUKMOYB," navigate to the P-frame catalog by using the link provided.

Look at pages 16-17 of the pdf catalog to find the nomenclature of the breaker.

Search the P-frame spec sheet using the search "PJL36120."

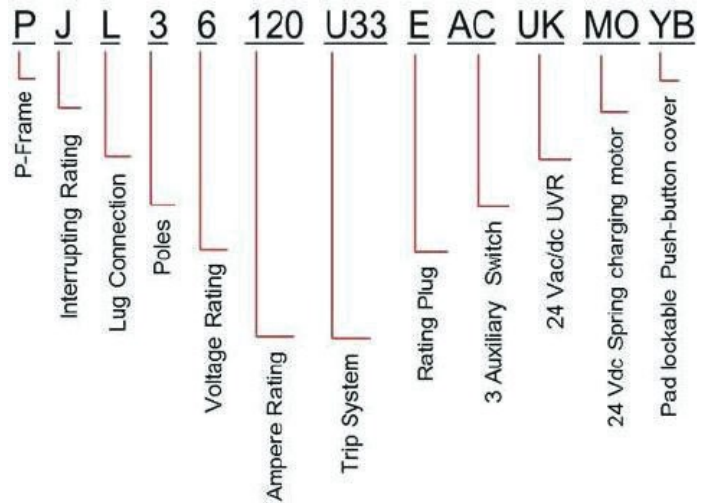

The following link is another way to decode the Schneider products

https://www.productinfo.schneider-electric.com/portals/ui/digest/viewer/561d5d65e4b0c5c41a243bf2/561d5f9ae4b0c5c41a24480c/r/_17707021_83351#_17707021_83351

For decoding the ABB breakers, see the decoder sheet, titled "T8 Catalog number explanation"

Mechanically operated breakers							
Feature Code	Breaker box description	Cummins part #	Engine	Manufacturer	Breaker catalog number	Trip unit	Plug type
KP82-2	CB-2500, Right, 3P, UL600, IEC 415, UL Serv Ent, 100%	0320-2164-01	QST30-G5, 30L, QSK50-G4, QSK50-G5, QSK50-G7, QSK60-G6, QSK60-G11 QSK60-G14, QSK60-G18	Schneider Electric	RLF36250U31F	MicroLogic 3.0 LI	F
		A054K364	QSK19-G8, QSK23-G7		RLF36250U33F	MicroLogic 5.0 LSI	
KP83-2	CB-2500A, Left, 3P, 600, IEC 415, UL Serv Ent, 100%	0320-2164-01	QST30-G5, 30L, QSK50-G4, QSK50-G5, QSK50-G7, QSK60-G6, QSK60-G11 QSK60-G14, QSK60-G18	Schneider Electric	RLF36250U31F	MicroLogic 3.0 LI	F
		A054K364	QSK19-G8, QSK23-G7		RLF36250U33F	MicroLogic 5.0 LSI	
KP84-2	CB-2000, Right, 3P, UL 600, IEC 415, UL Serv Ent 100%	0320-2164-02	QST30-G5, 30L, QSK50-G4, QSK50-G5, QSK50-G7, QSK60-G6, QSK60-G11 QSK60-G14, QSK60-G18	Schneider Electric	RLF36200U31F	MicroLogic 3.0 LI	F
		A054K366	QSK19-G8, QSK23-G7		RLF36200U33F	MicroLogic 5.0 LSI	
KP85-2	CB-2000, Left, 3P, UL 600, IEC 415, UL Serv Ent, 100%	0320-2164-02	QST30-G5, 30L, QSK50-G4, QSK50-G5, QSK50-G7, QSK60-G6, QSK60-G11 QSK60-G14, QSK60-G18	Schneider Electric	RLF36200U31F	MicroLogic 3.0 LI	F
		A054K366	QSK19-G8, QSK23-G7		RLF36200U33F	MicroLogic 5.0 LSI	
KP86-2	CB-1600A, Right, 3P, UL 600, IEC 415, UL Serv Ent 100%	0320-2164-03	QST30-G5, 30L, QSK50-G4, QSK50-G5, QSK50-G7, 50L, QSK60-G6, QSK60-G11 QSK60-G14, QSK60-G18	Schneider Electric	RLF36160U31F	MicroLogic 3.0 LI	F
		A054K368	QSK19-G8, QSK23-G7		RLF36160U33F	MicroLogic 5.0 LSI	
KP87-2	CB-1600, Left, 3P, UL 600, IEC 415, UL Serv Ent 100%	0320-2164-03	QST30-G5, 30L, QSK50-G4, QSK50-G5, QSK50-G7, QSK60-G6, QSK60-G11 QSK60-G14, QSK60-G18	Schneider Electric	RLF36160U31F	MicroLogic 3.0 LI	F
		A054K368	QSK19-G8, QSK23-G7		RLF36160U33F	MicroLogic 5.0 LSI	
KP88-2	CB-1200, Right, 3P, UL 600, IEC 415, UL Serv Ent, 100%	0320-2183	QST30-G5, 30L, QSK50-G4, QSK50-G5, QSK50-G7, QSK60-G6, QSK60-G11 QSK60-G14, QSK60-G18	Schneider Electric	PJP36120U31E	MicroLogic 3.0 LI	E
		A054K408	QSK19-G8, QSK23-G7		PJP36120U33F	MicroLogic 5.0 LSI	
KP89-2	CB-1200, Left, 3P, UL 600, IEC 415, UL Serv Ent 100%	0320-2183	QST30-G5, 30L, QSK50-G4, QSK50-G5, QSK50-G7, QSK60-G6, QSK60-G11 QSK60-G14, QSK60-G18	Schneider Electric	PJP36120U31E	MicroLogic 3.0 LI	E
		A054K408	QSK19-G8, QSK23-G7		PJP36120U33F	MicroLogic 5.0 LSI	
KP90-2	CB-800A, Right, 3P, UL 600, IEC 415, UL Serv Ent 100%	0320-2182	QST30-G5, 30L, QSK50-G4, QSK50-G5, QSK50-G7, QSK60-G6, QSK60-G11 QSK60-G14, QSK60-G18	Schneider Electric	PJP36080U31F	MicroLogic 3.0 LI	F
		A054K405	QSK19-G8, QSK23-G7		PJP36080U33F	MicroLogic 5.0 LSI	
KP91-2	CB-800A, Left, 3P, UL 600, IEC 415, UL Serv Ent, 100%	0320-2182	QST30-G5, 30L, QSK50-G4, QSK50-G5, QSK50-G7, QSK60-G6, QSK60-G11 QSK60-G14, QSK60-G18	Schneider Electric	PJP36080U31F	MicroLogic 3.0 LI	F
		A054K405	QSK19-G8, QSK23-G7		PJP36080U33F	MicroLogic 5.0 LSI	
KP92-2	CB-600A, Right, 3P, UL 600, IEC 690, UL Serv Ent 100%	A044T468	QSK19-G8, QSK23-G7, 30L, QSK50-G4, QSK50-G5, QSK50-G7, QSK60-G6, QSK60-G11 QSK60-G14, QSK60-G18	Schneider Electric	NLGL36600U33X-600A	MicroLogic 3.3S LSI	N/A
KP93-2	CB-600A, Left, 3P, UL 600, IEC 690, UL Serv Ent, 100%	A044T468	QSK19-G8, QSK23-G7, 30L, QSK50-G4, QSK50-G5, QSK50-G7, QSK60-G6, QSK60-G11 QSK60-G14, QSK60-G18	Schneider Electric	NLGL36600U33X-600A	MicroLogic 3.3S LSI	N/A
KU62-2	CB-3000A, 3P, 600/690V, UL/IEC, ServEnt, 100%UL, Right	A029B150	QSK50-G5, QSK50-G7, QSK60-G6, QSK60-G11 QSK60-G14, QSK60-G18	Schneider Electric	RLF36300U31A	MicroLogic 3.0 LI	F
KU68-2	CB-3000A, 3P, 600/690V, UL/IEC, ServEnt, 100%UL, Left	A029B150	QSK50-G5, QSK50-G7, QSK60-G6, QSK60-G11 QSK60-G14, QSK60-G18	Schneider Electric	RLF36300U31A	MicroLogic 3.0 LI	F

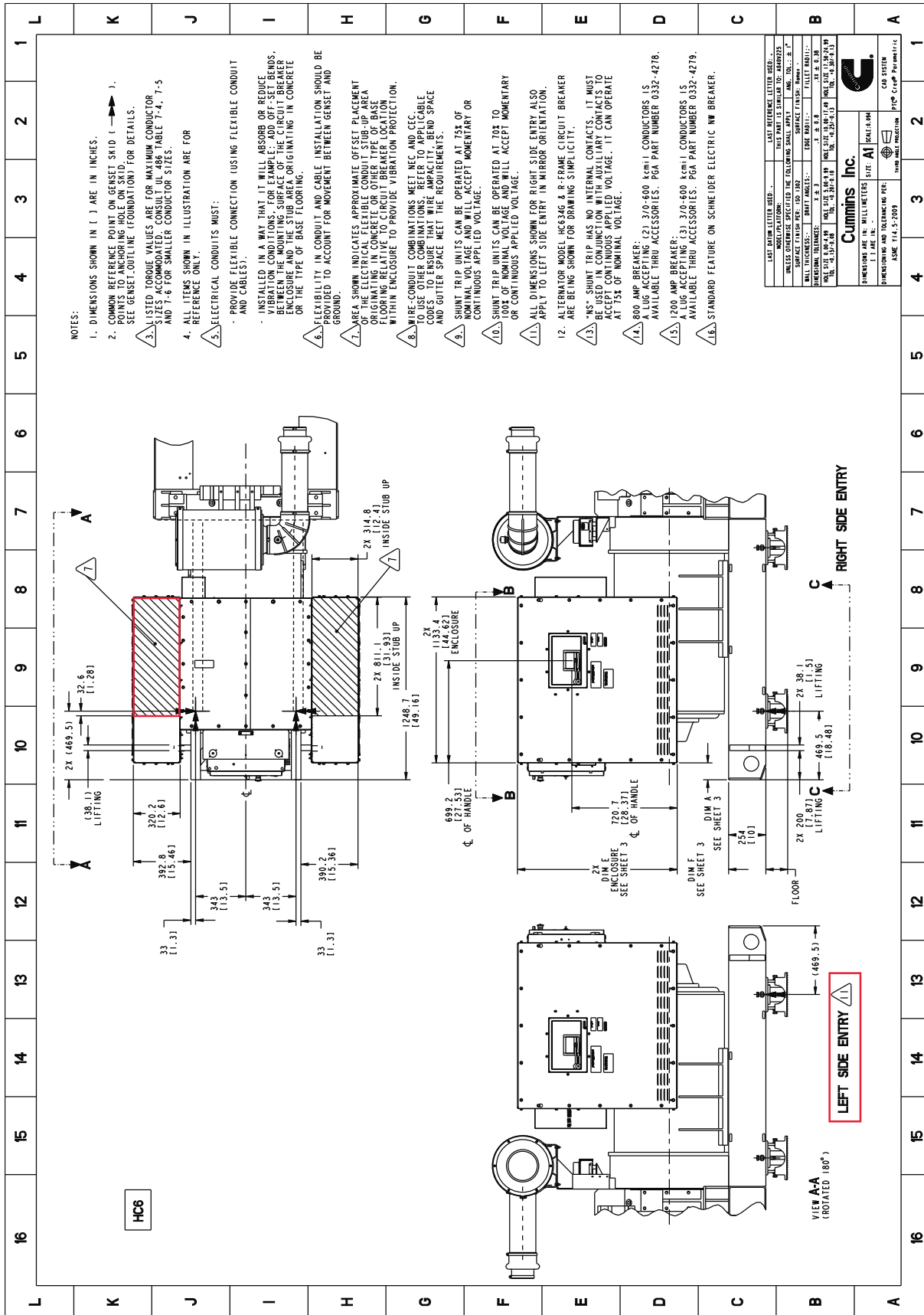

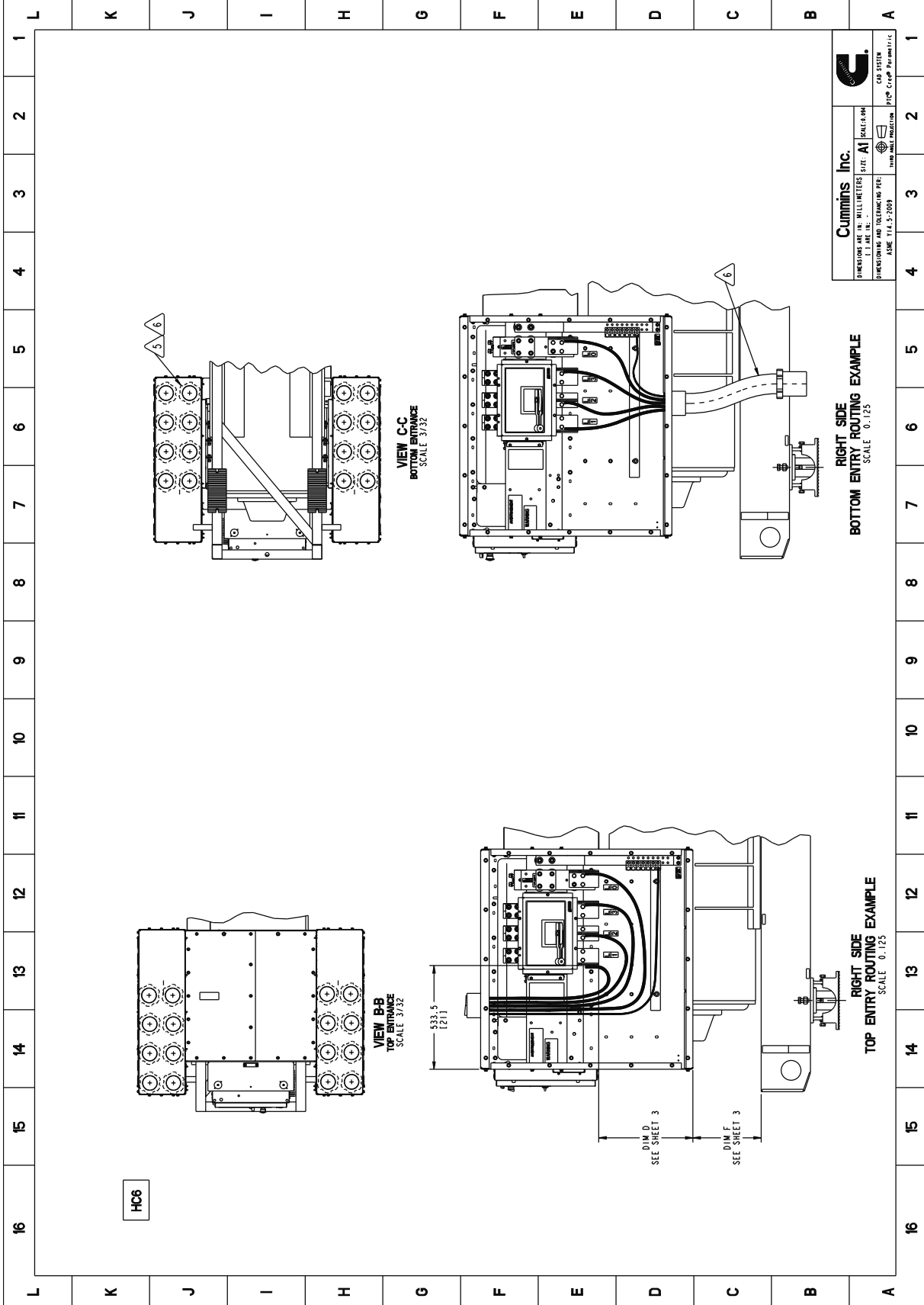

Cummins Inc.		Cummins
DIMENSIONS ARE IN: MILLIMETERS	SIZE: A1	SCALE: 0.125
DIMENSIONS UNLESS OTHERWISE SPECIFIED	STANDARD FINISH	ISO CRISP PRACTICES
ASME Y14.5-2009	ISO 15724	ISO 15724

Part Number: **A054F847** Part Revision: **G**
 Part Name: **OUTLINE,GENSET**
 Drawing Category: **Detail State: Released** Sheet 2 of 6

This document (and the information shown thereon) is **Confidential and Proprietary** and shall not be disclosed to others in hard copy or electronic form, reproduced by any means, or used for any purpose without written consent of Cummins Inc.

TABLE 1 ACCESSORY SPECIFICATIONS														
LUG	FRAME	WIRE RANGE COPPER	DIM. D A±.25 T±.01	DIM. E H±.25 T±.01	DIM. F L±.01	DIM. G W±.0001 L±.01	DIM. H H±.02 L±.01	DIM. I H±.02 L±.01	DIM. J H±.02 L±.01	DIM. K H±.02 L±.01	DIM. L H±.02 L±.01	UL/IEC LUGS		
												MAX. AMPS	WIRE RANGE COPPER	
	SQUARE D NUGL W/MICROLOGIC 3-3S TRIP UNIT	2/0-350 KCMIL 600A 3-POLE	554 [21.8]	1092 [43.02]	351.1 [13.82]	9.3	9.3	9.3	9.3	9.3	9.3	9.3	24 VDC SHUNT TRIP	10A Δ 0
	SQUARE D 8000 W/MICROLOGIC 5.0 TRIP UNIT	3/0-500 KCMIL 800A 3-POLE	599 [23.5]	1092 [43.02]	351.1 [13.82]	9.3	9.3	9.3	9.3	9.3	9.3	9.3	24 VDC SHUNT TRIP	200VA Δ 0
	SQUARE D P 1200 W/MICROLOGIC 3.0 TRIP UNIT	3/0-500 KCMIL 1200A 3-POLE	556 [21.8]	1092 [43.02]	351.1 [13.82]	9.3	9.3	9.3	9.3	9.3	9.3	9.3	24 VDC SHUNT TRIP	200VA Δ 0
	SCHMIDT ELECTRIC 1600-3000 AMP BREAKERS (ELECTRICALLY OPERATED) BUS BARS STANDARD W/MICROLOGIC 3.0 TRIP UNIT	NEMA HOLE PATTERN	473.2 [18.63]	1242.6 [48.92]	201.1 [7.92]	9.3	9.3	9.3	9.3	9.3	9.3	9.3	24 VDC SHUNT TRIP	200VA Δ 0
	SQUARE D R 2500/2000/1600 3-POLE BUS BARS STANDARD W/MICROLOGIC 5.0 TRIP UNIT	NEMA HOLE PATTERN	490 [19]	1092 [43.02]	351.1 [13.82]	9.3	9.3	9.3	9.3	9.3	9.3	9.3	24 VDC SHUNT TRIP	200VA Δ 0
	SCHMIDT ELECTRIC 1600-3000 AMP BREAKERS (ELECTRICALLY OPERATED) W/OPTIONAL LUG TORQUE 315 IN LBS (142 Nm)	#2-600 KCMIL	473.2 [18.63]	1242.6 [48.92]	201.1 [7.92]	9.3	9.3	9.3	9.3	9.3	9.3	9.3	24 VDC SHUNT TRIP	200VA Δ 0
	SQUARE D R 2500/2000/1600 W/OPTIONAL LUG 1600-2500 AMP BREAKERS TORQUE 315 IN LBS (142 Nm)	#2-600 KCMIL	490 [19]	1092 [43.02]	351.1 [13.82]	9.3	9.3	9.3	9.3	9.3	9.3	9.3	24 VDC SHUNT TRIP	200VA Δ 0

TABLE 2
TYPICAL CONDUIT AND WIRE SIZE BASED ON NEC 2014, ARTICLE 310.15
FOR USE WITH 600V AND 800V AIR CONDITIONERS, A/C REFRIGERATORS,
RATED CONDUCTOR AT 30C AMBIENT AND AME2 C WITH 4 CURRENT-CARRYING
CONDUCTORS IN EACH CONDUIT

MAX BRK AMPS	WIRE (COPPER)		CABLE AMPACITY		TOTAL NUMBER OF CONDUITS	
	QTY	SIZE	QTY	SIZE (IN INCHES)	QTY	SIZE (IN INCHES)
3000A	8	600 KCMIL	380	8	4	4
2500A	7	600 KCMIL	380	7	4	4
2000A	6	500 KCMIL	344	6	4	4
1600A	6	350 KCMIL	280	6	3 1/2	3 1/2
1200A	4	400 KCMIL	304	4	3 1/2	3 1/2
800A	3	350 KCMIL	280	3	3	3
600A	3	470 AWG	208	3	3	3

TYPICAL CONDUIT AND WIRE SIZE BASED ON NEC 2014, ARTICLE 310.15
FOR USE WITH 600V AND 800V AIR CONDITIONERS, A/C REFRIGERATORS,
RATED CONDUCTOR AT 30C AMBIENT AND AME2 C WITH 4 CURRENT-CARRYING
CONDUCTORS IN EACH CONDUIT

MAX BRK AMPS	WIRE (COPPER)		CABLE AMPACITY		TOTAL NUMBER OF CONDUITS	
	QTY	SIZE	QTY	SIZE (IN INCHES)	QTY	SIZE (IN INCHES)
3000A	8	700 KCMIL	379	8	4	4
2500A	8	500 KCMIL	313	8	4	4
2000A	8	350 KCMIL	255	8	3	3
1600A	7	300 KCMIL	233	7	3	3
1200A	4	500 KCMIL	313	4	4	4
800A	4	250 KCMIL	211	4	3	3
600A	3	250 KCMIL	211	3	3	3

TYPICAL CONDUIT AND WIRE SIZE BASED ON NEC 2014, ARTICLE 310.15
FOR USE WITH 600V AND 800V AIR CONDITIONERS, A/C REFRIGERATORS,
RATED CONDUCTOR AT 30C AMBIENT AND AME2 C

TABLE 3

GENSET MODEL	ALTERNATOR MODEL	DIM. "A"
<input type="checkbox"/> DOCA	<input type="checkbox"/> HC634G	14.54
<input type="checkbox"/> DOCB	<input type="checkbox"/> HC634H	11.5.3
<input type="checkbox"/> DOCC	<input type="checkbox"/> HC634J	11.5.3
	<input type="checkbox"/> HC634K	14.3
	<input checked="" type="checkbox"/> S6D	13.92
	<input type="checkbox"/> S6E	11.9.4
		14.71

Cummins Inc.

DIMENSIONS ARE IN MILLIMETERS SIZE: A1 (SCALE: 1:50)

DRAWING AND DOCUMENTING PER: [Logo]

ASME Y14.5-2009

CAD SYSTEM: [Logo]

GROUP: [Logo]

PROP: [Logo]

DATE: 11/19/2020

SCALE: 1:1

0500_4022

HEATER AMPERAGE TABLE		FEATURE CODE	
SINGLE PHASE HEATER VOLTAGE	HEATER AMPS	HEATER WATTS	ONE HEATER TOTAL WATTS
208	18.0	3744	23.2 4825
240	20.8	4990	26.75 6420
480	10.4	4990	13.375 6420

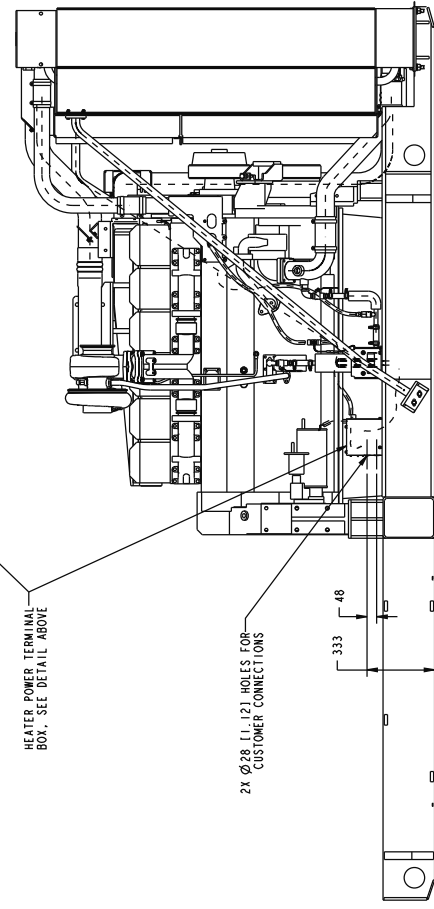
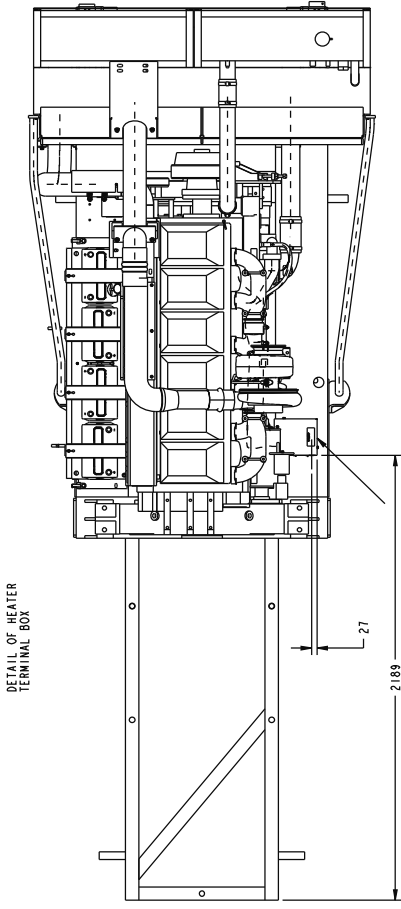
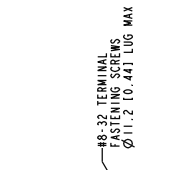
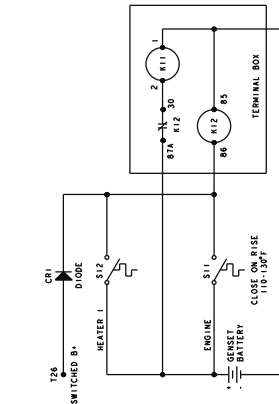
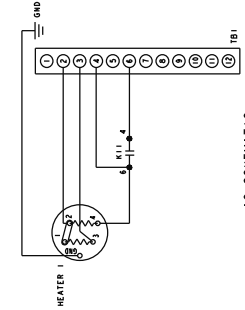
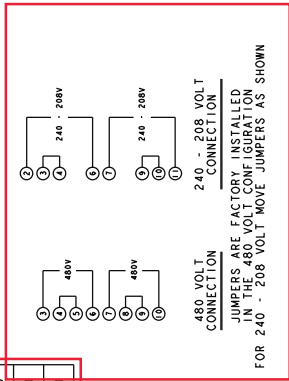

LAST DIMENSION USED: THIS PART IS SHOWN TO: UNLESS OTHERWISE SPECIFIED, DIMENSIONS ARE IN MILLIMETERS (INCHES). DIMENSIONS ARE IN MILLIMETERS (INCHES). DIMENSIONS AND TOLERANCING PER: ANSI Y14.5M-1982

Cummins Inc. SCALE: 1:1

Cummins Data Classification: **Confidential and Proprietary**

This document (and the information shown thereon) is **Confidential and Proprietary** and shall not be disclosed to others in hard copy or electronic form, reproduced by any means, or used for any purpose without written consent of Cummins Inc.

Part Number: 0500-4022 Part Revision: C
 Part Name: OUTLINE, HEATER INTERFACE
 Drawing Category: Detail State: Released

Sheet 1 of 2



Enclosures and Tanks

250-1000 kW Gensets



Enclosure Standard Features

- 14-gauge steel construction (panels)
- Stainless steel hardware
- Zinc phosphate pretreatment, e-coat primer and super durable powder topcoat paint minimize corrosion and color fade
- Package listed to UL 2200
- Designed to satisfy national electrical code installation requirements
- Fuel and electrical stub-up area within enclosure perimeter
- Fixed louvers
- Cambered roof prevents water accumulation
- Recessed, lockable doors in two sides
- Retainers hold doors open for easy access
- Enclosed exhaust silencer ensures safety and protects against rust
- Rain cap
- Exterior oil and coolant drains with interior valves for ease of service
- Rodent barriers on inlet
- Non-hydroscopic sound attenuating material
- Side mounted controls and circuit breakers
- Easy access lifting points for spreader bars
- Dual vibration isolation system (250-500 kW)
- Spring vibration isolation system (600-1000 kW)
- Enclosure mounts to lifting base or fuel tank (250-500 kW)
- Enclosure mounts to lifting base (600-1000 kW)
- Factory pre-assembled package
- Designed for outdoor use only
- Externally mounted emergency stop button for operator safety (optional on 250-500 kW)
- Horizontal air discharge to prevent leaf and snow accumulation (600-1000 kW)

Options

- **Three levels of sound attenuation**
- Motorized louvers to protect from ice and snow accumulation (available on air inlet for all models and on air outlet on level II, 250-500 kW enclosures only)
- **Horizontal air discharge, sound level 2 only (250-500 kW)**
- Aluminium construction with roll-coated polymer paint
- Wind rated to 150 mph
- Neutral sandstone paint color
- Factory mounted battery charger
- External 120 VAC service outlet
- Rain hoods for air inlet (250-500 kW)
- Lifting base in lieu of a sub-base tank (250-500 kW)
 - Pre-wired AC distribution package
 - 100 amp (250-500 kW) or 150 amp (600-1000 kW) main circuit breaker; connected to 120 VAC Line-Neutral and 208 or 240 VAC Line-Line, spare breaker positions and capacity for future upgrades (600-1000 kW)
 - GFCI protected internal 120 VAC service receptacle
 - GFCI protected weather proof external 120 volt service receptacle
 - All factory installed AC powered features pre-wired into load center
- Interior lights – 120 volt (600-1000 kW)
- Rain hoods for air inlet (250-500 kW)
- Seismic isolators available (600-1000 kW)

Fuel Tanks

Standard sub-base tank features

- UL 142 Listed
- ULC-S601-07 Listed
- NFPA37 compliant
- Dual walled, steel construction
- Emergency tank and rupture basin vents
- Tank mounted mechanical fuel gauge
- Fuel supply and return tubes
- Top mounted leak detection float switch
- Low and high level fuel switches
- Mounting brackets for optional pump and control (250-500 kW)
- Integral lifting points

Sub-base tank options

- Pre-wired fuel pump and control
- Fuel overfill alarm – internal or external
- Overflow and tank fill plugs
- Five gallon spill fill box – internal or external
- Fill pipe extender
- Local code approvals available

200-500 kW Dual Wall Sub-base Fuel Tanks – usable operating hours

Genset model (60 Hz)	Gallons /hour at full load	270 gallon tank	300 gallon tank	400 gallon tank	500 gallon tank	600 gallon tank	660 gallon tank	720 gallon tank	850 gallon tank	1420 gallon tank	1470 gallon tank	1700 gallon tank	2050 gallon tank	2525 gallon tank
250 DQDAA	20	14	15	20	25	30	33	36		72	74		104	
275 DQDAB	21	13	14	19	24	29	31	34		66	70		96	
300 DQDAC	23	12	13	17	22	26	29	31		61	64		88	
300 DQHAB	23	12	13	17	22	26	29		37			74		
450 DFEJ	30	9	10	13	17	20	22		28			57		84
500 DFEK	34	8	9	11	15	18	19		25			50		74

Operating hours are measured at 60 Hz, standby rating.

600-1000 kW Dual Wall Sub-base Fuel Tanks – usable operating hours

Genset model	Gallons /hour at full load	200 gallon tank	660 gallon tank	1000 gallon tank	1500 gallon tank	2000 gallon tank	2400 gallon tank
600 DQCA	42	5	16	24	36	48	57
600 DQPAA	45	4	15	22	33	44	53
650 DQPAB	50	4	13	20	30	40	48
750 DQCB	51	4	13	20	29	39	47
750 DQFAA	53	4	12	19	28	38	45
800 DQCC	53	4	12	19	28	38	45
800 DQFAB	56	4	12	18	27	36	43
900 DQFAC	64	3	10	16	23	31	38
1000 DQFAD	72	3	9	14	21	28	33

*3000 gallon tank offered as an accessory kit – refer to NAAC-5853 spec sheet.

- Operating hours are measured at 60 Hz, standby rating.
- Up to 90% fill alarm to comply with NFPA30, operating capacity is reduced by 10%.

Enclosure Package Sound Pressure Levels @ 7 meters dB(A)

Genset model	Weather protective enclosure (F200, F203)	QuietSite level 1 sound attenuated enclosure (F201, F204)	QuietSite level 2 sound attenuated enclosure (F202, F205)
250 DQDAA	90	88	72
275 DQDAB	90	88	73
300 DQDAC	90	88	73
300 DQHAB	89	88	76
450 DFEJ	88	85	74
500 DFEK	89	87	73
600 DQCA	90.6/86*	79.3/78*	74.1/73*
600 DQPAA	89.10	80.70	74.70
650 DQPAB	89.70	81.40	75
750 DQCB	91.1/87*	79.9/79*	75.3/74*
750 DQFAA	87.8	77.8	73.8
800 DQCC	91.3/87*	80.2/79*	75.7/74*
800 DQFAB	88.1	78.3	74
900 DQFAC	88.8	79.1	74.6
1000 DQFAD	89.6	80.1	75.3

- All data is 60 Hz, full load standby rating, steel enclosures only.
- Data is a measured average of 8 positions.
- Sound levels for aluminium enclosures are approximately 2 dB(A) higher than listed sound levels for steel enclosures.
- * Sound data with seismic feature codes L228-2 (IBC) and/or L225-2 (OSHPD)

Package Dimensions of Enclosure, Exhaust System, and UL Tank

250-500 kW

Tank size (gal)	Weather protective package length (in)	QuietSite level 1 package length (in)	QuietSite level 2 package length (in)	Width (in)	Height (in)	Weather protective package weight (lbs)	QuietSite level 1 package weight (lbs)	QuietSite level 2 package weight (lbs)
270	188	188	222	82	106	4991	5471	6711
300	188	188	222	82	104	5648	6073	6991
400	188	188	222	82	106	5833	6258	7176
500	188	188	222	82	108	5956	6381	7299
600	188	188	222	82	111	6116	6541	7459
660	188	188	222	82	113	6235	6660	7578
720	188	188	222	82	114	6174	6599	7517
850	188	188	222	82	118	6529	6954	7872
1420	200	200	222	82	128	6863	7343	8583
1470	192	192	222	82	128	7253	7733	8973
1700	234	234	234	82	128	7982	8407	9325
2050	284	284	284	82	128	8383	8863	10103
2525	346	346	346	82	128	9391	9871	11111
Lifting base	188	188	222	82	100	4335	4760	5678



600-1000 kW

Tank size (gal)	Weather protective package length (in)	QuietSite level 1 package length (in)	QuietSite level 2 package length (in)	Width (in)	Height (in)	Weather protective package weight (lbs)	QuietSite level 1 package weight (lbs)	QuietSite level 2 package weight (lbs)
200	260	303	315	98	137	10194	13074	14954
660	260	303	315	98	137	9586	12466	14346
1000	260	303	315	98	141	10117	12997	14877
1500	260	303	315	98	146	10677	13557	15437
2000	292	327	327	98	143	11959	14839	16719
2400	338	338	338	98	143	12961	15841	17721

- This weight does not include the generator set. Consult your local Cummins distributor or the appropriate generator specification sheet.

- Width is 86" lifting eye to lifting eye (250-500 kW), 102" lifting eye to lifting eye (600-1000 kW).
- Height - Florida, Michigan, and Suffolk add 6.4" (250-500 kW) or 2" (600-1000 kW) for bottom space.
- Maximum length emergency vent removed.

see below drawings for overall shipping weight and dimensions

	CSA - The generator set is CSA certified to product class 4215-01.
	UL - The generator set is available listed to UL 2200, stationary engine generator assemblies. The PowerCommand® control is listed to UL 508 - Category NITW7 for U.S. and Canadian usage.

For more information contact your local Cummins distributor or visit power.cummins.com

Our energy working for you.™



REFERENCE ONLY

see below drawings for overall shipping weight and dimensions

**FEATURE CODE
F202,F205
OPTIONAL FEATURE
CODE K074,K102**

- NOTES:
1. DIMENSIONS SHOWN IN () ARE INCHES.
 2. FOUNDATION REFERENCE POINT (---), SEE FOUNDATION DRAWING FOR DETAILS.

MODEL		STEEL ENCLOSURE WEIGHT ±5%	ALUMINUM ENCLOSURE WEIGHT ±5%	CG-DIM "A"	CG-DIM "B"	CG-DIM "C"	DIM.D ± TS (3)
D00CB D00C	HCGG	12338 (27202)	10884 (23904)	2038 (180.2)		846 (33.3)	
	HCEH	12489 (27533)	10934 (24251)	2021 (176.6)		845 (33.3)	
	HCEJ	12494 (27537)	11149 (24661)	2013 (175.5)		844 (33.2)	
	S8D	12338 (27202)	11482 (25463)	2031 (180.9)		846 (33.3)	1529 (60)
	S8E	12489 (27533)	10884 (23904)	2038 (180.2)		845 (33.3)	
	HCEI	11315 (25014)	9916 (21866)	2021 (178.6)		1035 (41.1)	1490 (59)
	HCEJ	11355 (25044)	10091 (22260)	2128 (83.1)		1034 (41.3)	
	HCEG	12006 (26474)	10553 (23266)	2000 (181.9)		1034 (41.3)	1599 (63)
	HCEH	12016 (26524)	10621 (23416)	2032 (180.8)		1033 (41.3)	
	HCEI	12311 (27274)	10916 (24066)	2020 (179.5)	1244.7 (49)	794 (31.3)	
DFGA,DFGE	HCEG	12634 (27853)	11179 (24645)	2005 (181.3)		791 (31.1)	1570 (62)
	HCEH	12872 (28377)	11417 (25169)	2041 (180.4)		788 (31.1)	
	HCEJ	13095 (28869)	11640 (25661)	2017 (178.4)		787 (31.1)	
	HCEK	13170 (29034)	11715 (25826)	2009 (177.1)		786 (30.9)	1688 (67)
	PTB	13296 (29234)	11801 (26016)	1980 (177.2)		784 (30.9)	
	PTC	13314 (29244)	12059 (26586)	1945 (176.6)		794 (31.3)	
	S8D	12634 (27853)	11179 (24645)	2005 (181.3)		791 (31.1)	1570 (62)
	S8E	12872 (28377)	11417 (25169)	2041 (180.4)		788 (31.1)	
	HCSF	13095 (28869)	11640 (25661)	2017 (178.4)		827 (32.6)	
	HCEG	11608 (25592)	10754 (23385)	2039 (181.1)		826 (32.5)	1438 (56.6)
D0PAA, D0PAB	HCEH	11846 (26117)	10391 (22903)	2081 (181.9)		823 (32.4)	

*** WEIGHT & CG'S ARE SHOWN WITH F202 STEEL ENCLOSURE, AND STANDARD WET GENSET. ADDITION OF OTHER FEATURES MAY CHANGE THE WEIGHT.

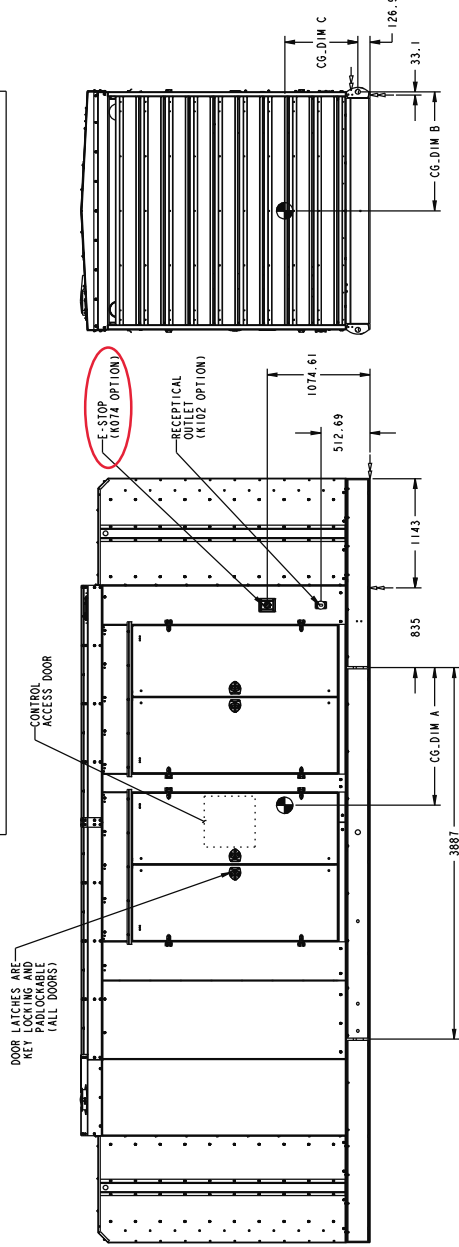

LAST DIMENSION LETTER USED...	LAST REFERENCE LETTER USED...
MULTIPLICATION...	THIS PART IS SIMILAR TO: D00C-A1P7
UNLESS OTHERWISE SPECIFIED THE FOLLOWING SHALL APPLY: FINISHES: 1. 2. 3. 4. 5. 6. 7. 8. 9. 10. 11. 12. 13. 14. 15. 16. 17. 18. 19. 20. 21. 22. 23. 24. 25. 26. 27. 28. 29. 30. 31. 32. 33. 34. 35. 36. 37. 38. 39. 40. 41. 42. 43. 44. 45. 46. 47. 48. 49. 50. 51. 52. 53. 54. 55. 56. 57. 58. 59. 60. 61. 62. 63. 64. 65. 66. 67. 68. 69. 70. 71. 72. 73. 74. 75. 76. 77. 78. 79. 80. 81. 82. 83. 84. 85. 86. 87. 88. 89. 90. 91. 92. 93. 94. 95. 96. 97. 98. 99. 100.	
WALL THICKNESS: 1. 2. 3. 4. 5. 6. 7. 8. 9. 10. 11. 12. 13. 14. 15. 16. 17. 18. 19. 20. 21. 22. 23. 24. 25. 26. 27. 28. 29. 30. 31. 32. 33. 34. 35. 36. 37. 38. 39. 40. 41. 42. 43. 44. 45. 46. 47. 48. 49. 50. 51. 52. 53. 54. 55. 56. 57. 58. 59. 60. 61. 62. 63. 64. 65. 66. 67. 68. 69. 70. 71. 72. 73. 74. 75. 76. 77. 78. 79. 80. 81. 82. 83. 84. 85. 86. 87. 88. 89. 90. 91. 92. 93. 94. 95. 96. 97. 98. 99. 100.	
DIMENSIONAL TOLERANCES: 1. 2. 3. 4. 5. 6. 7. 8. 9. 10. 11. 12. 13. 14. 15. 16. 17. 18. 19. 20. 21. 22. 23. 24. 25. 26. 27. 28. 29. 30. 31. 32. 33. 34. 35. 36. 37. 38. 39. 40. 41. 42. 43. 44. 45. 46. 47. 48. 49. 50. 51. 52. 53. 54. 55. 56. 57. 58. 59. 60. 61. 62. 63. 64. 65. 66. 67. 68. 69. 70. 71. 72. 73. 74. 75. 76. 77. 78. 79. 80. 81. 82. 83. 84. 85. 86. 87. 88. 89. 90. 91. 92. 93. 94. 95. 96. 97. 98. 99. 100.	
Cummins Inc. DIMENSIONS ARE IN MILLIMETERS SIZE: A1 (SCALE: 1:1) DIMENSIONS AND TOLERANCES PER: ASME Y14.5-2009 SHEET METAL FINISH: 1100 Cr24P CUMMINS PART NUMBER: 30MAV2019 21:13 GMT	

REFERENCE ONLY

see below drawings for overall shipping weight and dimensions

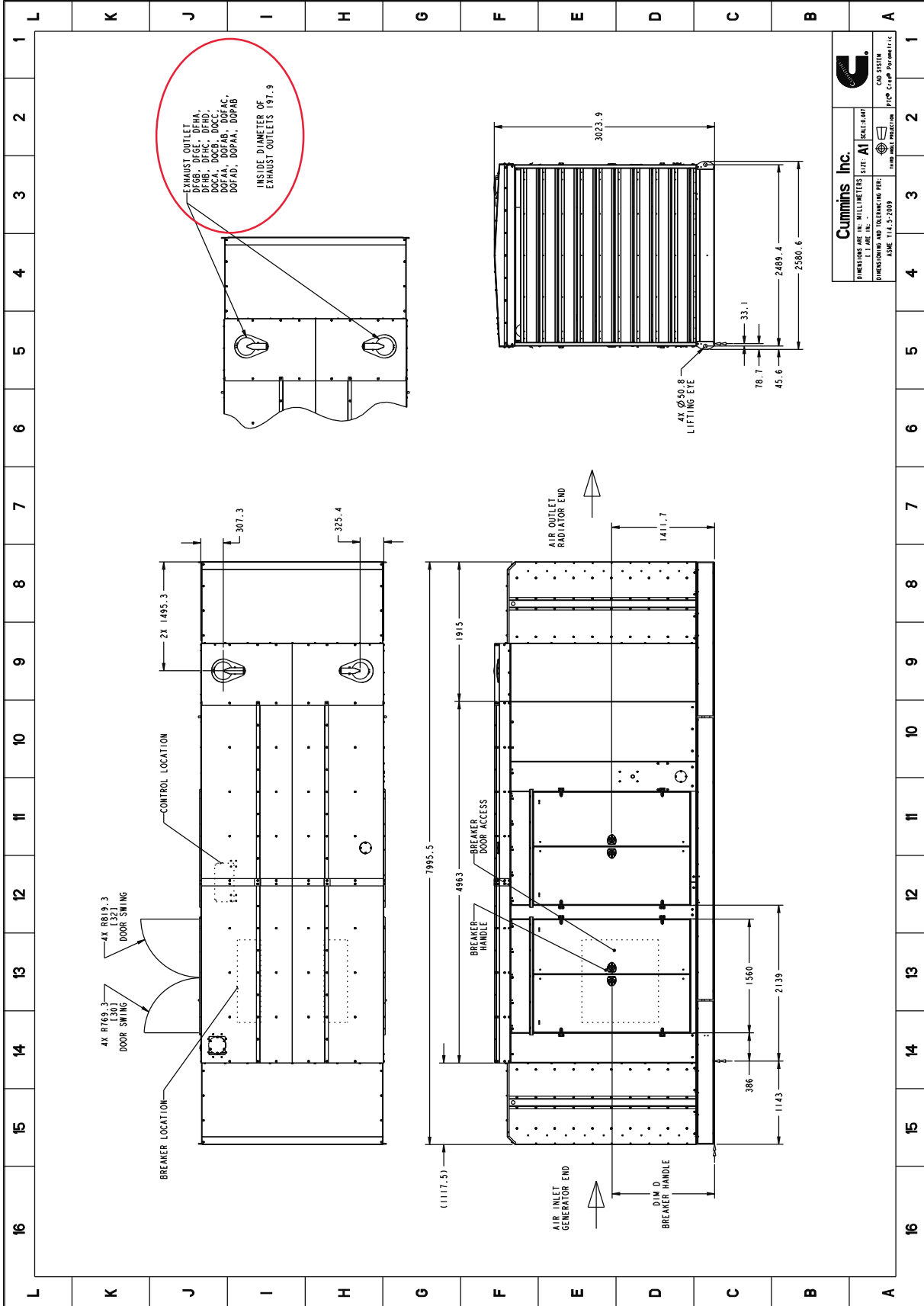

Cummins Inc.		CUMMINS INC.	
DIMENSIONS ARE IN MILLIMETERS	SIZE: A1 (SCALE: 1:1)	CUB SYSTEM	
DIMENSIONS AND TOLERANCES PER:	ASME Y14.5-2009	HATCH PATTERN: HATCH GROUP: Parametric	

Part Number: A034L228 Part Revision: F
 Part Name: OUTLINE, ENCLOSURE
 Drawing Category: Detail State: Released Sheet 2 of 3

This document (and the information shown thereon) is Confidential and Proprietary and shall not be disclosed to others in hard copy or electronic form, reproduced by any means, or used for any purpose without written consent of Cummins Inc.

Cummins Data Classification: Cummins Confidential

USE THIS DRAWING FOR OVERALL SHIPPING DIMENSIONS

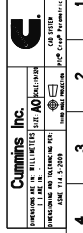
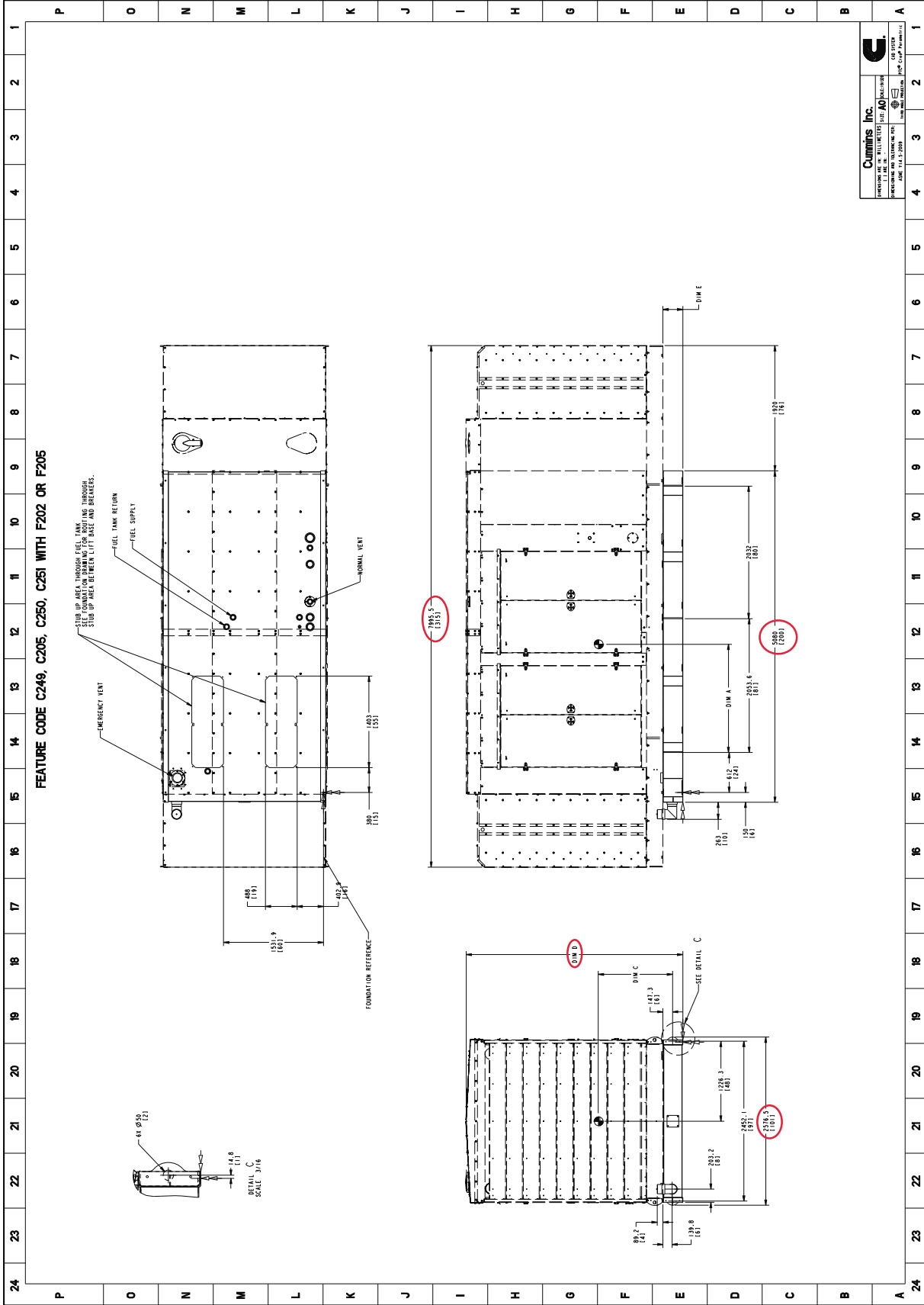

Part Number: **A035J956** Part Revision: **J**
 Part Name: **OUTLINE, FUEL SYSTEM**
 Drawing Category: **Detail State: Released** Sheet 3 of 7

This document (and the information shown thereon) is
Confidential and Proprietary and shall not be disclosed to others
 in hard copy or electronic form, reproduced by any means, or used
 for any purpose without written consent of Cummins Inc.

USE THIS DRAWING FOR OVERALL SHIPPING DIMENSIONS

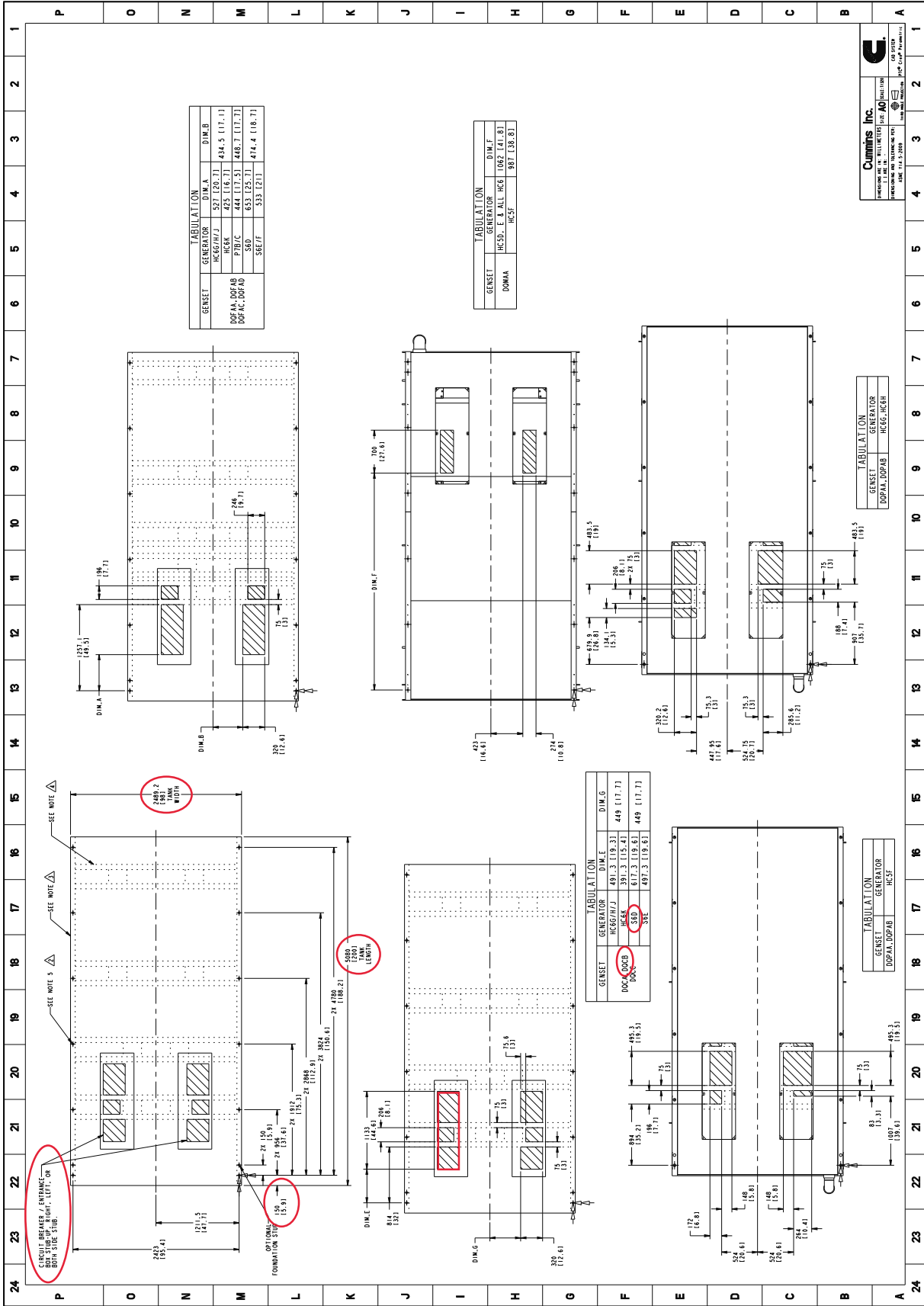

Part Number: **A035J956** Part Revision: **J**
 Part Name: **OUTLINE, FUEL SYSTEM**
 Drawing Category: **Detail State: Released** Sheet 4 of 7

This document (and the information shown thereon) is **Confidential and Proprietary** and shall not be disclosed to others in hard copy or electronic form, reproduced by any means, or used for any purpose without written consent of Cummins Inc.

USE THIS DRAWING FOR OVERALL SHIPPING DIMENSIONS

24	23	22	21	20	19	18	17	16	15	14	13	12	11	10	9	8	7	6	5	4	3	2	1	P	O	N	M	L	K	J	I	H	G	F	E	D	C	B	A
MANUFACTURER																																							
LEVEL 2 ENCLOSURE LITRE CODE F202 OR F205																																							
LEVEL 2 ENCLOSURE LITRE CODE F202 OR F205	MODEL	GENERATOR	WT (LBS)	CO. DIM (IN)	CO. DIM (IN)	CO. DIM (IN)	DIM. 3																																
C249	200 GALLON 224 (101)	DOCA_0000	6549	3278	2620	2737	103	103	103																														
		DOCA_0000	6549	3278	2620	2737	103	103	103																														
		DOCA_0000	6549	3278	2620	2737	103	103	103																														
		DOCA_0000	6549	3278	2620	2737	103	103	103																														
		DOCA_0000	6549	3278	2620	2737	103	103	103																														
		DOCA_0000	6549	3278	2620	2737	103	103	103																														
		DOCA_0000	6549	3278	2620	2737	103	103	103																														
		DOCA_0000	6549	3278	2620	2737	103	103	103																														
		DOCA_0000	6549	3278	2620	2737	103	103	103																														
		DOCA_0000	6549	3278	2620	2737	103	103	103																														
		DOCA_0000	6549	3278	2620	2737	103	103	103																														
		DOCA_0000	6549	3278	2620	2737	103	103	103																														
		DOCA_0000	6549	3278	2620	2737	103	103	103																														
		DOCA_0000	6549	3278	2620	2737	103	103	103																														
DOCA_0000	6549	3278	2620	2737	103	103	103																																
C285	650 GALLON 650 (300) 305 (127)	DOCA_0000	6549	3278	2620	2737	103	103	103																														
		DOCA_0000	6549	3278	2620	2737	103	103	103																														
		DOCA_0000	6549	3278	2620	2737	103	103	103																														
		DOCA_0000	6549	3278	2620	2737	103	103	103																														
		DOCA_0000	6549	3278	2620	2737	103	103	103																														
		DOCA_0000	6549	3278	2620	2737	103	103	103																														
		DOCA_0000	6549	3278	2620	2737	103	103	103																														
		DOCA_0000	6549	3278	2620	2737	103	103	103																														
		DOCA_0000	6549	3278	2620	2737	103	103	103																														
		DOCA_0000	6549	3278	2620	2737	103	103	103																														
		DOCA_0000	6549	3278	2620	2737	103	103	103																														
		DOCA_0000	6549	3278	2620	2737	103	103	103																														
		DOCA_0000	6549	3278	2620	2737	103	103	103																														
		DOCA_0000	6549	3278	2620	2737	103	103	103																														
DOCA_0000	6549	3278	2620	2737	103	103	103																																
C281	650 GALLON 650 (300) 305 (127)	DOCA_0000	6549	3278	2620	2737	103	103	103																														
		DOCA_0000	6549	3278	2620	2737	103	103	103																														
		DOCA_0000	6549	3278	2620	2737	103	103	103																														
		DOCA_0000	6549	3278	2620	2737	103	103	103																														
		DOCA_0000	6549	3278	2620	2737	103	103	103																														
		DOCA_0000	6549	3278	2620	2737	103	103	103																														
		DOCA_0000	6549	3278	2620	2737	103	103	103																														
		DOCA_0000	6549	3278	2620	2737	103	103	103																														
		DOCA_0000	6549	3278	2620	2737	103	103	103																														
		DOCA_0000	6549	3278	2620	2737	103	103	103																														
		DOCA_0000	6549	3278	2620	2737	103	103	103																														
		DOCA_0000	6549	3278	2620	2737	103	103	103																														
		DOCA_0000	6549	3278	2620	2737	103	103	103																														
		DOCA_0000	6549	3278	2620	2737	103	103	103																														
DOCA_0000	6549	3278	2620	2737	103	103	103																																

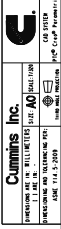

Part Number: A035J956 Part Revision: J
Part Name: OUTLINE, FUEL SYSTEM
Drawing Category: Detail State: Released

This document (and the information shown thereon) is Confidential and Proprietary and shall not be disclosed to others in hard copy or electronic form, reproduced by any means, or used for any purpose without written consent of Cummins Inc.

Cummins Data Classification: Cummins Internal Use Only

Battery Charger

A048G602 10A 50/60 Hz

A051H785 20A 50/60 Hz



Description

Cummins Power Generation fully automatic battery chargers are constant voltage/constant current chargers incorporating a 4-stage charging algorithm. Designed for use in applications where battery life and reliability are important; these chargers, complete with built-in equalize charge capability, are ideal for stationary or portable starting battery charging service.

To achieve optimum battery life, a 4-stage charging cycle is implemented. The four charging stages are constant current, high-rate taper charge, finishing charge, and maintaining charge. During the constant current cycle the charger operates at maximum possible output in the fast charge mode. During the high-rate taper charge cycle the charger stays at fast charge voltage level until battery current acceptance falls to a portion of the charger rated output. During the finishing charge cycle the charger operates at the float voltage and completes the battery charge. During the maintaining charge cycle the charger supplies only a few milliamps required by the battery to stay at peak capability.

An optional temperature sensor (A043D534) may be used to adjust charging voltage based on temperature of the battery. Use of a battery temperature sensor helps to increase battery life by preventing over or under charging. The battery temperature sensor also protects the battery from overheating. Temperature compensation sensor is required for all applications when battery charger and battery are located in different temperature or battery heater is being used.

Battery chargers are field-configurable for charging either 12 or 24 VDC battery systems at 50/60 Hz operation. Simple jumper selectors enable selection of output voltage and battery type.

Features

Protection – Surge protected to IEEE and EN standards. All models include single pole cartridge type fuses mounted on the printed circuit board to protect against input or output overcurrent.

Easy installation – Clearly marked terminal blocks and panel knockouts provide convenient connections of input and output leads.

User display – Output voltage and current, fault information and status are indicated on the front panel. Includes precision ammeter and voltmeter.

Monitoring – Status LED indicators are provided to show the condition of the charger. LED's on the right side of the monitor indicate operational functions for Temperature Compensation active (Green), AC on (Green), Float (Green) or Boost (Amber) mode, as well as Battery Fault (Red). LED's on the left side of the monitor illuminate (in Red) when Charger fail, High or Low VDC or AC fail occur.

Adjustable float voltage – Float voltage can be set, using easy to understand jumpers, for optimum battery performance and life.

Construction – NEMA-1 (IP20) corrosion resistant aluminum enclosure designed for wall mounting.

Faults – The charger senses and annunciates the following fault conditions: AC power loss, battery overvoltage, battery under voltage, battery fault conditions and charger failure. Includes an individual 30 volt/2 amp isolated contact for each alarm.

Vibration resistant design – complies with UL991 class B vibration resistance requirements.

Listed – C-UL listed to UL 1236 CSA standard 22.2 No 107.2-M89. Suited for flooded and AGM lead acid and NiCd batteries in generator set installations.

Warranty – 5 year CPG warranty.



Status and Fault LED



Field selectable jumper

Specifications

Performance and physical characteristics

Output:	Nominal voltage	12VDC* or 24VDC
	Float voltage– 12VDC batteries	12.87, 13.08, 13.31, 13.50*, 13.62, 14.30
	Float voltage– 24VDC batteries	25.74, 26.16, 26.62, 27.00*, 27.24, 28.60
	Equalize-voltage	6.5% above float voltage sensing
	Output voltage regulation	±0.5% (1/2%) line and load regulation
	Maximum output current	10 or 20 amps nominal
	Equalize charging	Battery interactive auto-boost
Input:	Voltage AC	120, 208, 240 ±10%
	Frequency	60/50 Hz ±5%
Approximate net weight:		10A: 25 lbs. (11.36 Kg) 20A: 50 lbs. (22.68 Kg)
Approximate dimensions: height x width x depth-in		10A: 12.50" x 7.66" x 6.50"(318x195x165 mm) 20A: 13.06" x 13.95" x 6.83"(332x354x173 mm)
Ambient temperature operation: At full rated output		- 4°F to 104 °F (-20 °C to 45 °C)

Note:

- Battery charger comes with default settings of 12VDC and 13.50/27.00VDC float voltage and can be changed to the battery manufacture recommendations. Replacement printed circuit board and fuses are identified in the Owner's Manual (10A: A050S537 and 20A: A051X126) which resides in Quick Serve On-Line. Service parts can be purchased through the Memphis Distribution Center. The PC board replacement instruction sheet (10A: A052N073, 20A: A053W929) and service manual (A050D829) is also available.
- Installation and application must comply with "section 4.5.3 batteries and battery charger" of application guide T-030 (Liquid Cooled Generator Set Application Manual A040S369).

Caution:

- Higher input voltages (i.e. 480VAC or 600VAC) can be applied if a transformer with a 120VAC-240VAC output is installed. For voltages higher than 240 VAC, step-down transformer must be used. Review the respective Owner/Installation manual A050S537 for 10Amp and A051X126 20A chargers for supplier recommended step-down transformer requirements.
- 10Amp battery charger is recommended for genset applications with 1 or 2 factory provided batteries. 20Amp battery charger is recommended for Cummins Genset applications with 3 or 4 factory provided batteries. Please consider the auxiliary DC loads connected to the genset batteries and size this charger as per the T-030 application guide to prevent misapplication issues.
- Back feed to a utility system can cause electrocution and/or property damage. Do not connect generator sets to any building electrical system except through an approved device or after building main switch is open.
- For professional use only. Must be installed by a qualified service technician. Improper installation presents hazards of electrical shock and improper operation, resulting in severe personal injury and/or property damage.
- Use this charger for charging LEAD-ACID or LIQUID ELECTROLYTE NICKEL-CADMIUM batteries only. Do not use this battery charger for charging dry cells, alkaline, lithium, nickel-metal hydride, or sealed nickel-cadmium batteries that are commonly used with home appliances. These batteries may burst and cause injuries to persons and damage to property.
- Do not parallel these battery chargers with any other charging system.

Americas
1400 73rd Avenue N.E.
Minneapolis, MN 55432 USA
Phone: 763 574 5000
Fax: 763 574 5298

Europe, CIS, Middle East and Africa
Manston Park Columbus Ave.
Manston Ramsgate
Kent CT 12 5BF United Kingdom
Phone 44 1843 255000
Fax 44 1843 255902

Asia Pacific
10 Toh Guan Road #07-01
TT International Tradepark
Singapore 608838
Phone 65 6417 2388
Fax 65 6417 2399

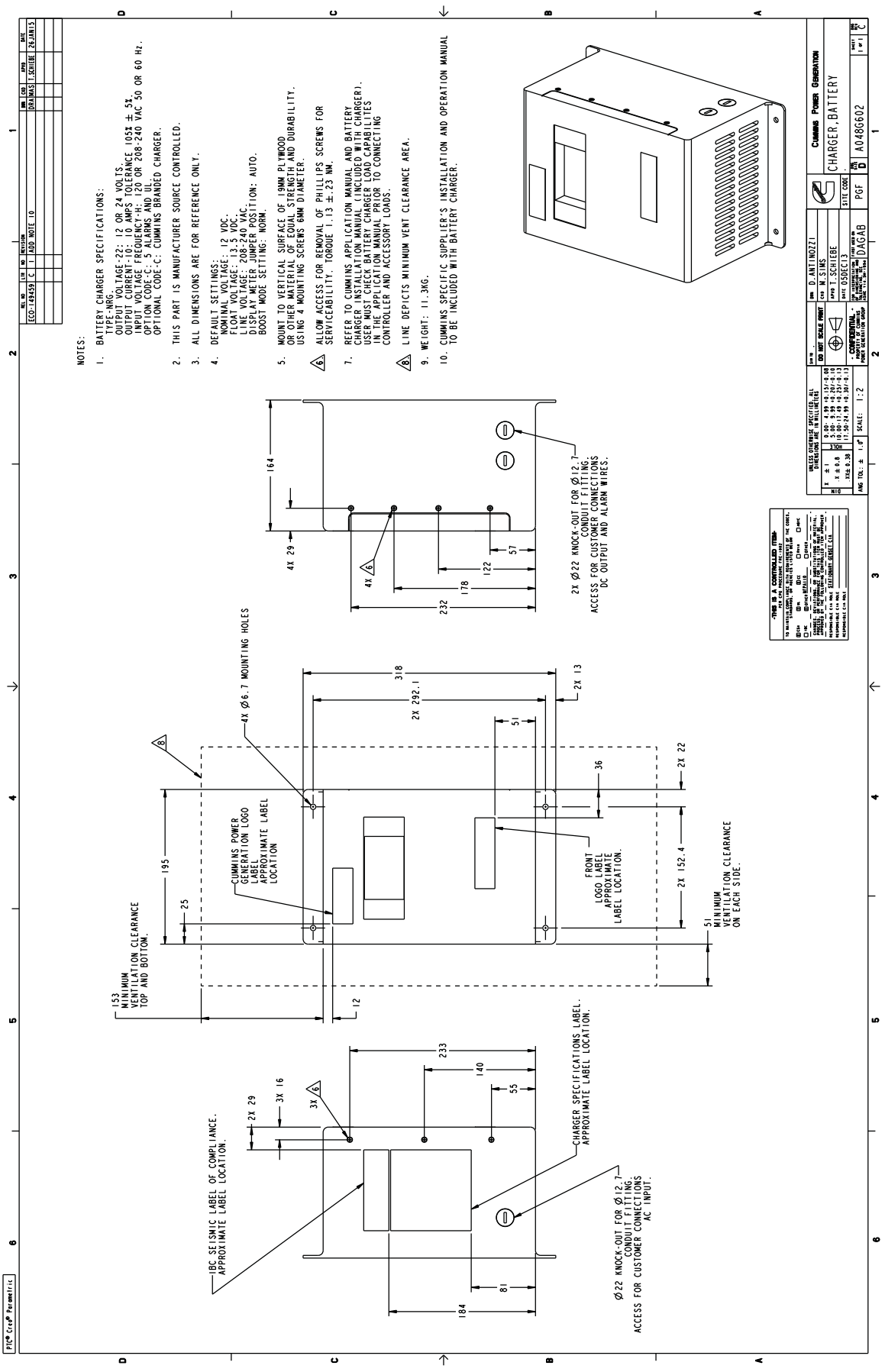

- NOTES:**
1. BATTERY CHARGER SPECIFICATIONS:
TYPE: HRC.
OUTPUT VOLTAGE: 22, 12 OR 24 VOLTS.
OUTPUT CURRENT: 10, 10 AMPS TOLERANCE: $10\% \pm 5\%$.
OPERATING FREQUENCY: 50 OR 60 HZ.
OPTIONAL CODES: 5 ALARMS AND 10 ALARMS.
OPTIONAL CODE-C: CUMMINS BRANDED CHARGER.
 2. THIS PART IS MANUFACTURER SOURCE CONTROLLED.
 3. ALL DIMENSIONS ARE FOR REFERENCE ONLY.
 4. DEFAULT SETTINGS:
APPLY VOLTAGE: 12 VDC.
FLOAT VOLTAGE: 13.5 VDC.
LINE VOLTAGE: 208-240 VAC.
DISPLAY METER JUMPER POSITION: AUTO.
BOOST MODE SETTING: NORM.
 5. MOUNT TO VERTICAL SURFACE OF 19MM PLYWOOD OR OTHER MATERIAL OF EQUAL STRENGTH AND DURABILITY. USING 4 MOUNTING SCREWS 6MM DIAMETER.
 6. ALLOW ACCESS FOR REMOVAL OF PHILLIPS SCREWS FOR SERVICEABILITY. TORQUE 1.13 ± 0.23 NM.
 7. REFER TO CUMMINS APPLICATION MANUAL AND BATTERY USER MANUAL FOR CHARGER AND BATTERY INFORMATION. USER MUST CHECK BATTERY CHARGER LOAD CAPABILITIES IN THE APPLICATION MANUAL PRIOR TO CONNECTING CONTROLLER AND ACCESSORY LOADS.
 8. LINE DEPICTS MINIMUM VENT CLEARANCE AREA.
 9. WEIGHT: 11.3KG.
 10. CUMMINS SPECIFIC SUPPLIER'S INSTALLATION AND OPERATION MANUAL TO BE INCLUDED WITH BATTERY CHARGER.

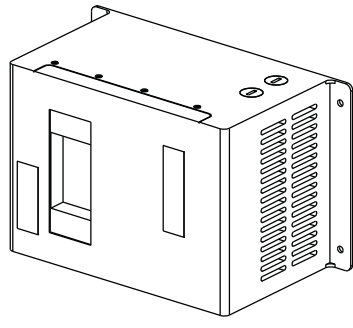

TABLE 2. 3. CUMMINS SPECIFIC DIMENSIONS

TO BE USED IN CONJUNCTION WITH THE DIMENSIONS OF THE CHARGER.

UNIT	MINIMUM CLEARANCE	MINIMUM CLEARANCE	MINIMUM CLEARANCE	MINIMUM CLEARANCE
mm	51	51	51	51
in	2.0	2.0	2.0	2.0

ECO: 149459	C	T	ADD NOTE 10	REV	DATE
1					
2					
3					
4					
5					
6					

1	UNIT NO: Z71	CUMMINS POWER GENERATION
2	REV: 5	CHARGER, BATTERY
3	DATE CODE: 13	
4	PGF: B	A0486602
5	REV: 1	C

PCC Terminal Straps	TBI
	1
	2
	3
	4
	5
	6
	7
	8
	9
	10
	11
	12
	13
	14
	15
	16
	17
	18
	19
	20
	21
	22
	23
	24
	25
	26
	27
	28
	29
	30
	31
	32
	33
	34
	35
	36
	37
	38
	39
	40
	41
	42
	43
	44
	45
	46
	47
	48
	49
	50
	51
	52
	53
	54
	55
	56
	57
	58
	59
	60
	61
	62
	63
	64
	65
	66
	67
	68
	69
	70
	71
	72
	73
	74
	75
	76
	77
	78
	79
	80
	81
	82
	83
	84
	85
	86
	87
	88
	89
	90
	91
	92
	93
	94
	95
	96
	97
	98
	99
	100

- 1. FTI-10 network cable use Belden 9471 or equivalent. Run cable between devices in a "daisy chain" configuration. See FTI-10 manual for max distances and further detail.
- 2. PCC NET network cable use Belden 9729 or equivalent. See Cummins documentation for max distances and further detail.
- 3. See wire size chart in battery charger installation manual or NEC Guide.
- 4. See instruction sheet CG2736 For Kodion II gateway kit pinout and further detail.
- 5. See instruction sheet CG2736 For Kodion II gateway kit pinout and further detail.
- 6. See AUX 101 / 102 Operator Manual for pinout and further detail.
- 7. See BDM for voltage.
- 8. See Protonade instruction guide for detailed wiring layout and more information.

Notes:



Project:
Title:
AUTHOR:
Date:

Revision: 15
Sheet: 1 of 1

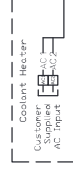
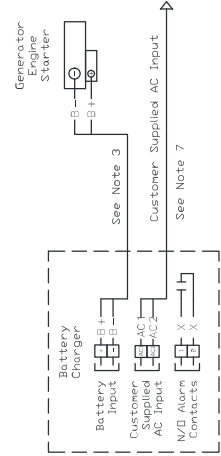

See Note 7

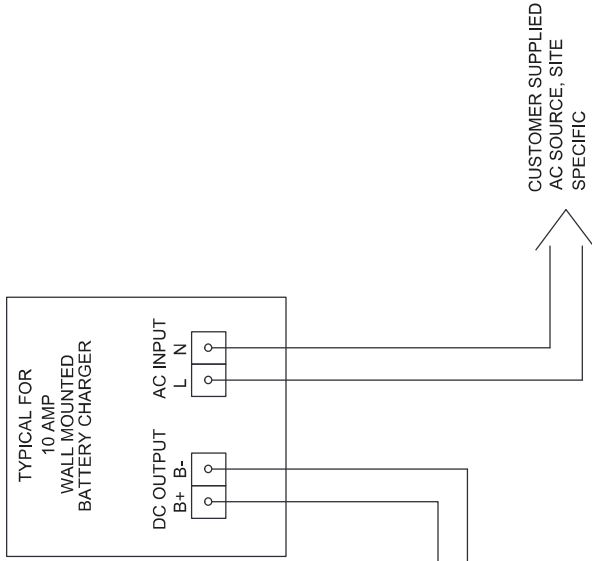

WIRE SIZE (AWG)	DISTANCE IN FEET (ONE WAY)				
	A	B	C	D	E
	CONTROL WIRING	2/3.5 AMP BATT CHG. 24V 12V	10 AMP BATT CHG. 24V 12V	12/15 AMP BATT CHG. 24V 12V	20 AMP BATT CHG. 24V 12V
16	1000	90 150	-	-	-
14	1600	150 90	20 5	20 5	-
12	2400	225 125	30 10	30 10	-
10	4000	350 200	50 15	50 15	30 15
8	-	600 300	80 25	80 25	50 25
6	-	1000 500	125 40	125 40	80 40

CUMMINS SALES AND SERVICE
 CONNECTICUT, INDIANA, KENTUCKY, MAINE
 MARYLAND, MASSACHUSETTS, MICHIGAN, NEW
 HAMPSHIRE, NEW JERSEY, NEW YORK, OHIO,
 PENNSYLVANIA, RHODE ISLAND, WEST VIRGINIA

AUTHOR: **D. BAUER** DATE: **27SEPT2016**
 DRAWING NAME: **TYP BATT CHARGER 9011** PAGE:

Limited Warranty

Commercial Generating Set

This limited warranty applies to all Cummins Power Generation® branded commercial generating sets and associated accessories (hereinafter referred to as "Product").

This warranty covers any failures of the Product, under normal use and service, which result from a defect in material or factory workmanship.

Warranty Period:

The warranty start date[†] is the date of initial start up, first rental, demonstration or 18 months after factory ship date, whichever is sooner. See table for details.

Continuous Power (COP) is defined as being the maximum power which the generating set is capable of delivering continuously whilst supplying a constant electrical load when operated for an unlimited number of hours per year. No overload capability is available for this rating.

Prime Power (PRP) is defined as being the maximum power which a generating set is capable of delivering continuously whilst supplying a variable electrical load when operated for an unlimited number of hours per year. The permissible average power output over 24 hours of operation shall not exceed 70% of the PRP. For applications requiring permissible average output higher than stated, a COP rating should be used.

Limited-Time Running Power (LTP) is defined as the maximum power available, under the agreed operating conditions, for which the generating set is capable of delivering for up to 500 hours of operation per year.

Emergency Standby Power (ESP) is defined as the maximum power available during a variable electrical power sequence, under the stated operating conditions, for which a generating set is capable of delivering in the event of a utility power outage or under test conditions for up to 500 hours of operation per year. The permissible average power output over 24 hours of operation shall not exceed 70% of the ESP.

Environmental Protection Agency – Stationary Emergency (EPA-SE) is defined as being the maximum power available during a variable electrical power sequence, under the stated operating conditions, for which a generator set is capable of delivering in the event of a utility power outage or under test conditions and used in strict accordance with the EPA NSPS for stationary engines, 40 CFR part 60, subparts IIII and JJJJ, where a reliable utility must be present. The permissible average power output over 24 hours of operation shall not exceed 70% of the EPA-SE.

Data Center Continuous (DCC) is defined as the maximum power which the generator is capable of delivering continuously to a constant or varying electrical load for unlimited hours in a data center application.

Base Warranty Coverage Duration (Whichever occurs first)

Rating	Months	Max. Hours
COP	12	Unlimited
PRP	12	Unlimited
LTP	12	500 hrs
ESP	24	1000 hrs
EPA-SE	24	Unlimited
DCC	24	Unlimited

[†] Warranty start date for designated rental and oil and gas model Products is determined to be date of receipt of Product by the end customer.

Cummins Power Generation® Responsibilities:

In the event of a failure of the Product during the warranty period due to defects in material or workmanship, Cummins Power Generation® will only be responsible for the following costs:

- All parts and labor required to repair the Product.
- Reasonable travel expenses to and from the Product site location.
- Maintenance items that are contaminated or damaged by a warrantable failure.

Owner Responsibilities:

The owner will be responsible for the following:

- Notifying Cummins Power Generation® distributor or dealer within 30 days of the discovery of failure.
- Installing, operating, commissioning and maintaining the Product in accordance with Cummins Power Generation®'s published policies and guidelines.
- Providing evidence for date of commissioning.
- Providing sufficient access to and reasonable ability to remove the Product from the installation in the event of a warrantable failure.
- Incremental costs and expenses associated with Product removal and reinstallation resulting from non-standard installations.
- Costs associated with rental of generating sets used to replace the Product being repaired.
- Costs associated with labor overtime and premium shipping requested by the owner.
- All downtime expenses, fines, all applicable taxes, and other losses resulting from a warrantable failure.

Limitations:

This limited warranty does not cover Product failures resulting from:

- Inappropriate use relative to designated power rating.
- Inappropriate use relative to application guidelines.
- Inappropriate use of an EPA-SE application generator set relative to EPA's standards.
- Normal wear and tear.
- Improper and/or unauthorized installation.
- Negligence, accidents or misuse.
- Lack of maintenance or unauthorized repair.
- Noncompliance with any Cummins Power Generation® published guideline or policy.
- Use of improper or contaminated fuels, coolants or lubricants.
- Improper storage before and after commissioning.
- Owner's delay in making Product available after notification of potential Product problem.
- Replacement parts and accessories not authorized by Cummins Power Generation®.
- Use of Battle Short Mode.
- Owner or operator abuse or neglect such as: operation without adequate coolant or lubricants; overfueling; overspeeding; lack of maintenance to lubricating, cooling or air intake systems; late servicing and maintenance; improper storage, starting, warm-up, run-in or shutdown practices, or for progressive damage resulting from a defective shutdown or warning device.

- Damage to parts, fixtures, housings, attachments and accessory items that are not part of the generating set.

This limited warranty does not cover costs resulting from:

- Difficulty in gaining access to the Product.
- Damage to customer property.

A "Data center" is defined as a dedicated facility that house computers and associated equipment for data storage and data handling.

Reliable utility is defined as utility power without routine or regularly scheduled black-outs.

Please contact your local Cummins Power Generation® Distributor for clarification concerning these limitations.

CUMMINS POWER GENERATION® RIGHT TO FAILED COMPONENTS:

Failed components claimed under warranty remain the property of Cummins Power Generation®. Cummins Power Generation® has the right to reclaim any failed component that has been replaced under warranty.

Extended Warranty:

Cummins Power Generation® offers several levels of Extended Warranty Coverage. Please contact your local Cummins Power Generation® Distributor for details.

www.power.cummins.com

THE WARRANTIES SET FORTH HEREIN ARE THE SOLE WARRANTIES MADE BY CUMMINS POWER GENERATION® IN REGARD TO THE PRODUCT. CUMMINS POWER GENERATION® MAKES NO OTHER WARRANTIES, EXPRESS OR IMPLIED, OR OF MERCHANTABILITY OR FITNESS FOR A PARTICULAR PURPOSE.

IN NO EVENT IS CUMMINS POWER GENERATION® LIABLE FOR INCIDENTAL OR CONSEQUENTIAL DAMAGES.

This limited warranty shall be enforced to the maximum extent permitted by applicable law. This limited warranty gives the owner specific rights that may vary from state to state or from jurisdiction to jurisdiction.

Product Model Number: _____
 Product Serial Number: _____
 Date in Service: _____